



## INCONTRO SINGOLO



Incontro singolo | One-rod junction  
Gache simple | Cerradero pletina individual



Corpo in nylon;  
vite M5 TSC CR e  
piastrina a a camma  
in acciaio inox.



Nylon body; stainless  
steel M5 TSC CR  
screw and cam plate.



Corps en nylon; vis  
M5 TSC CR et plaque  
à came en acier inox.



Cuerpo de nylon;  
tornillo M5 TSC CR y  
placa de acero inox.

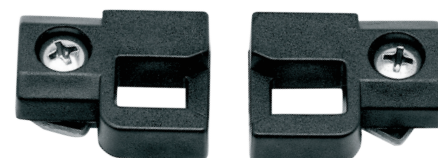

ART.	4216.5   4216.6			
Imballo   Package   Conditionnement   Embalaje	100 PZ			
Finiture disponibili   Available finishes Finitions disponibles   Acabados disponibles	1	2	3	4

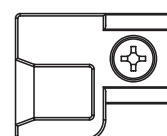
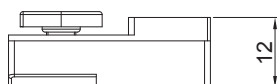
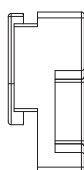
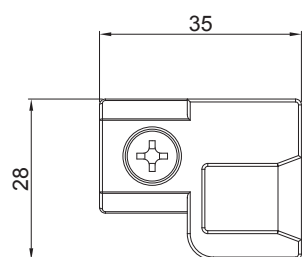

Art. 4216.5

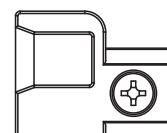

Art. 4216.6

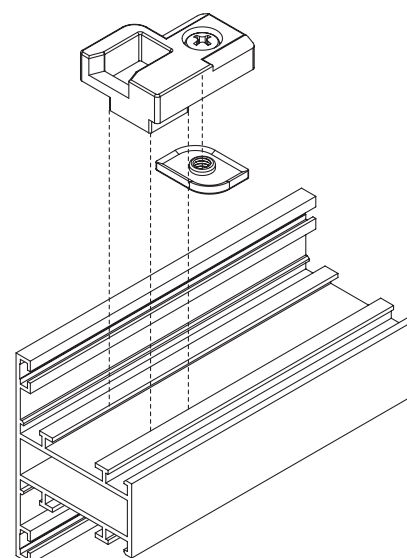

ART.	NODO SECTION
4216.5	A11 - A12 - B08
4216.6	A11 - A12 - B08