



ITALIA

MARTELLINA MINIMAL DESIGN



Martellina minimal design | Minimal design handle
Bequille a poignee design minimaliste | Maneta de diseño minimal

 Manico in alluminio pressofuso, tappo e rondella in nylon, bussola in zama, grano, molla e perno in acciaio inox.

 Handle in die-cast aluminium, nylon plug and washer, zamak bush, setscrew, stainless steel spring, setscrew and pin.

 Manche en aluminium moulé sous pression, nylon bouchon et rondelle, bague en zamak, grain, ressort et pivot en acier inox.

 Mango en aluminio de fundición, tapón y arandela en nylon, casquillo en zamak prisionero, muelle y perno en acero inoxidable.



ART.	3090 3090.1 3090.2 3090.3 3090.4			
Imballo Package Conditionnement Embalaje	5 PZ			
Finiture disponibili Available finishes Finitions disponibles Acabados disponibles	1	2	3	4

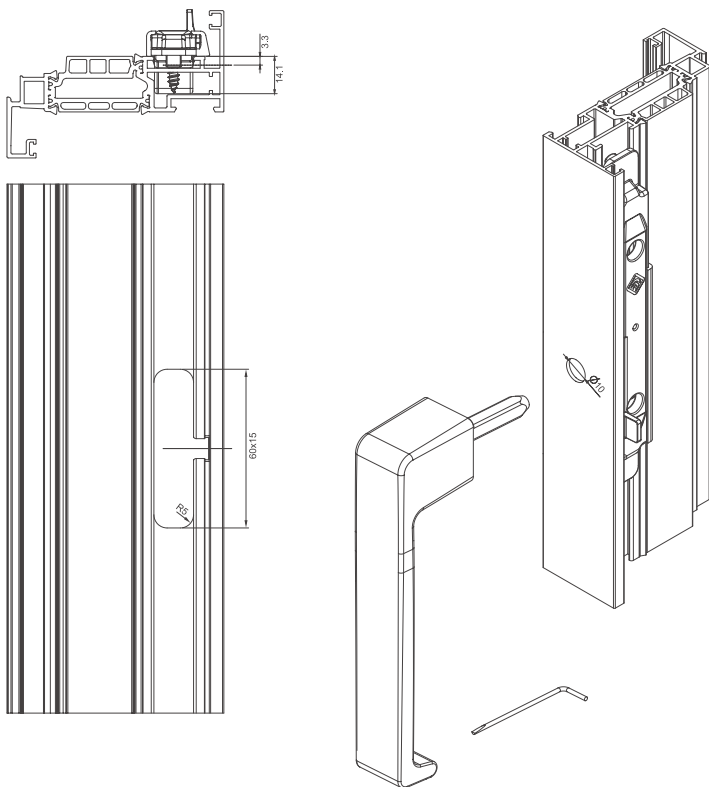

Art. 3090.1

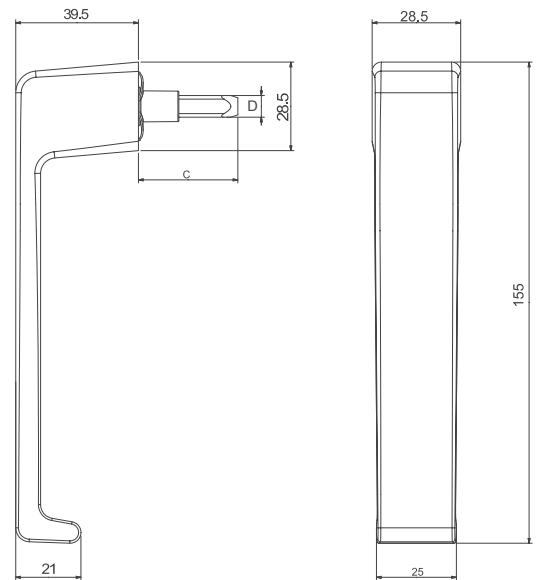

	DESCRIZIONE DESCRIPTION	ART.	C	D
	Martellina minimal design Minimal design handle	3090	24-33,5mm	7
	Martellina minimal design Minimal design handle	3090.1	34-43,5mm	7
	Martellina minimal design Minimal design handle	3090.2	39-48,5mm	7
	Martellina minimal design Minimal design handle	3090.3	49-58,5mm	7
	Martellina minimal design Minimal design handle	3090.4	69-78,5mm	7

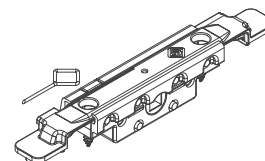

CE	ERRE40
3630.10	3631.10

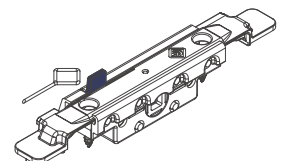

CE	ERRE40
3630	3631



Utilizzabile solo in abbinamento alla movimentazione
Art. 3630 | 3630.10 - Art. 3631 | 3631.10
Only usable with one way movement
Art. 3630 | 3630.10 - Art. 3631 | 3631.10