



TAPPO COPRILAVORAZIONE



Tappo coprilavorazione | Cover plug |
 Cache usinage | Tapón para cubrir la mecanización



Realizzato in nylon.



Made of nylon.



Réalisé en nylon.



Fabricado en nylon.



ART.	TUTTI ALL TOUS TODOS			
Imballo Package Conditionnement Embalaje	100 Pz			
Finiture disponibili Available finishes Finitions disponibles Acabados disponibles	1	2	3	4

Art. 6829.1

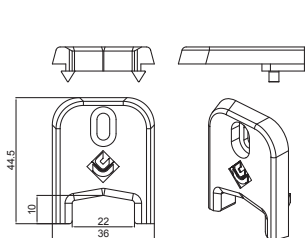

LAVORAZIONE
MACHINING

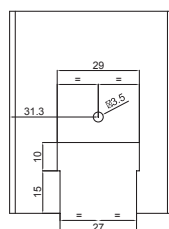

Art. 6824.3

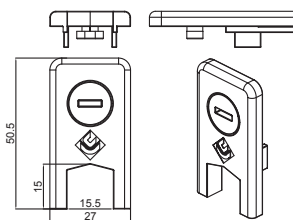

LAVORAZIONE
MACHINING

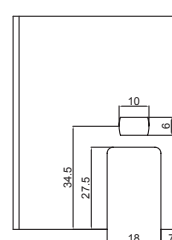

Art. 6830

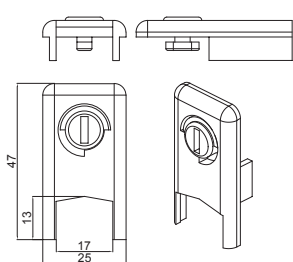

LAVORAZIONE
MACHINING

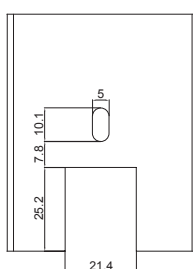

Art. 6827

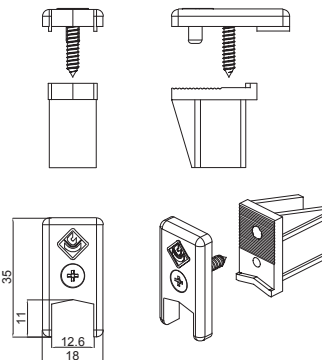

LAVORAZIONE
MACHINING

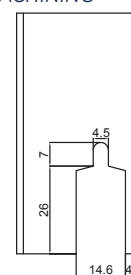

Art. 6824

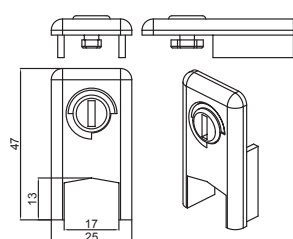

Art. 6824.5

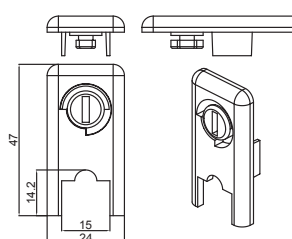

Art. 6824.4

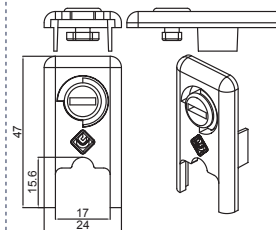

Art. 6825A

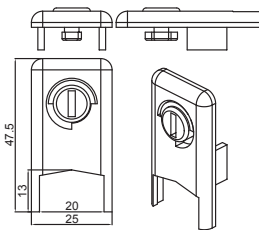

LAVORAZIONE
MACHINING

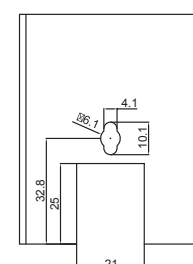

Art. 6825

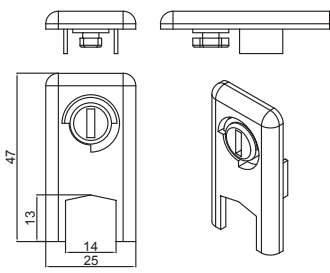

LAVORAZIONE
MACHINING

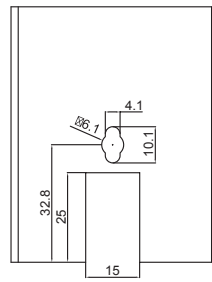

Art. 6825.1

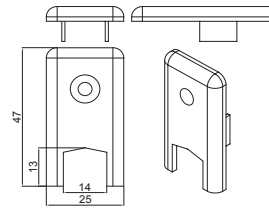

LAVORAZIONE
MACHINING

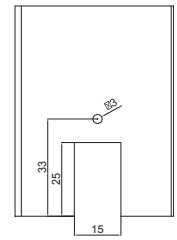

Art. 6821

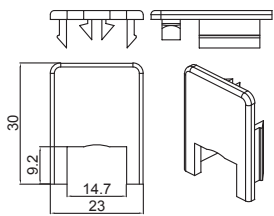

LAVORAZIONE
MACHINING

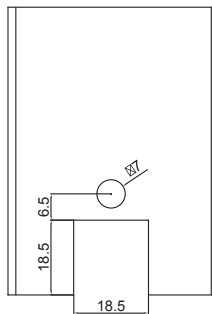

Art. 6822

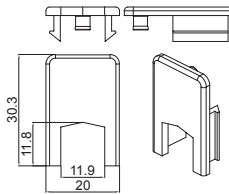

LAVORAZIONE
MACHINING

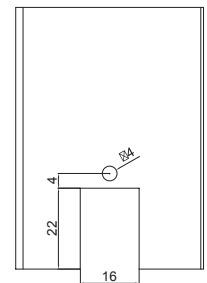

Art. 6823

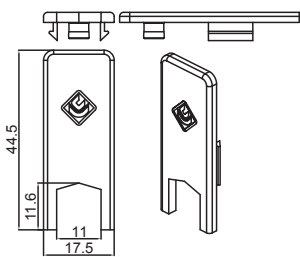

LAVORAZIONE
MACHINING

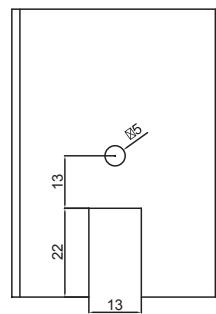

Art. 6829

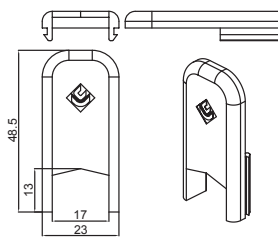

LAVORAZIONE
MACHINING

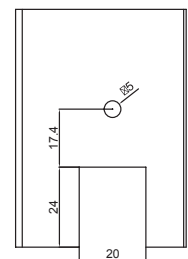

Art. 6860.2

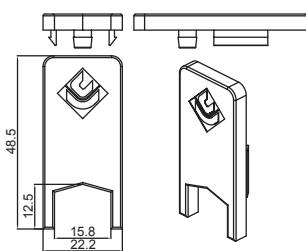

LAVORAZIONE
MACHINING

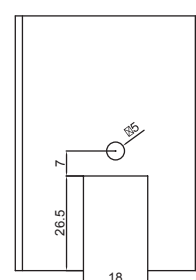

Art. 6861.1

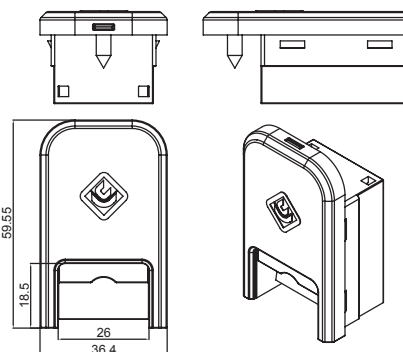

LAVORAZIONE
MACHINING

