



# APRO

## ATTUATORE A CATENA 350N 24V

Attuatore a Catena | Chain actuator  
Actionneur à chaîne | Actuador de cadena



Attuatore a Catena per aperture motorizzate di uno o più infissi a sporgere con comando a pulsante o tramite APP



Chain actuator for motorized opening of one or more top hinge windows with pushbutton control or via APP



Actionneur à chaîne pour l'ouverture motorisée d'une ou plusieurs fenêtres a soufflet avec commande à bouton-poussoir ou via APP



Actuador de cadena para apertura motorizada de uno o varios cerramientos proyectantes con mando por pulsador o vía APP

BREVETTATO  
PATENTED

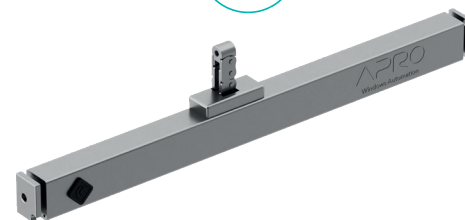

ART.	1123.1P   1123.2P 1123.3P   1123.10P				1123.16   1123.17 1123.20			
Imballo   Package   Conditionnement   Embalaje	1 Kit				5 pz			
Finiture disponibili   Available finishes Finitions disponibles   Acabados disponibles	1	2	3	4	1	2	3	4

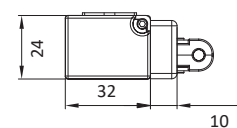
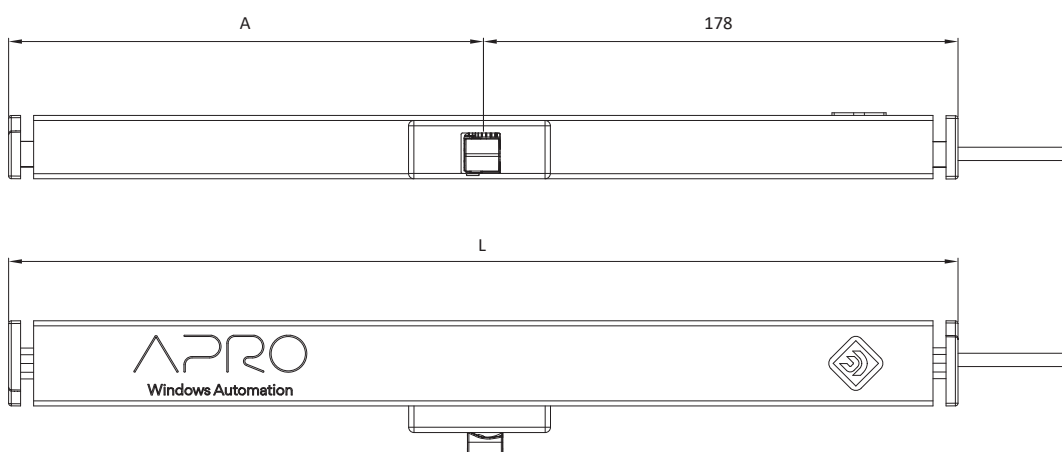

CODICE / CODE	A	L
1123.10P	178 mm	357 mm
1123.1P	224 mm	402 mm
1123.2P	276 mm	454 mm
1123.3P	375 mm	560 mm

DATI TECNICI   TECHNICAL DATA				
Codice Code	1123.10P	1123.1P	1123.2P	1123.3P
	CE350N24V210P	CE350N24V300P	CE350N24V400P	CE350N24V600P
Lunghezza L Length L	357 mm	402 mm	454 mm	560 mm
Corsa(selezionabile) Stroke	120, 160, 210 mm	150, 200, 300 mm	300, 350, 400 mm	500, 600 mm
Forza di trazione Pull force	350N			
Forza di spinta Push force	<p>* Per applicazioni con corsa maggiore di 300mm utilizzare in abbinamento alle cerniere a compasso della line Empire o Easy Rapid e verificare il diagramma di carico</p> <p>* For applications with a stroke longer than 300mm use in combination with the Empire or Easy Rapid line compass hinges and check the load diagram</p>			

Lunghezza cavo Cable length	1 m
Tensione alimentazione Rated voltage	24V DC
Assorbimento a carico nominale Rated current	0.5A
Assorbimento in allarme Alarm current	1A
Potenza assorbita a carico nominale Rated power	24W
Velocità Speed	6mm/s
Velocità in allarme Speed in alarm	12mm/s
Cicli per ora Duty cycle	10
Fine corsa apertura Stroke-end at opening	Elettronico / Electronic
Fine corsa chiusura Stroke-end at closing	Ad assorbimento di corrente At absorption of current
Peso Weight	400g   500g   600g   700g
Grado di protezione Protection index	IP32
Isolamento elettrico Electrical insulation	Classe III - Class III
Temperatura di funzionamento Operating temperature	-5°C+65°C



Art. 1123.16

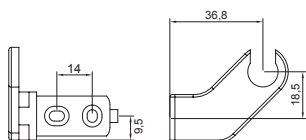
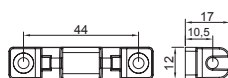
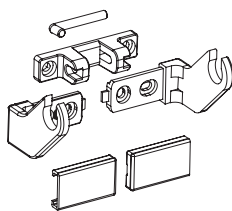

Art. 1123.17

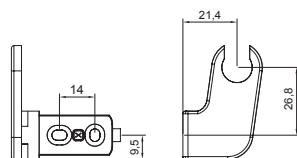
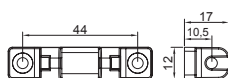
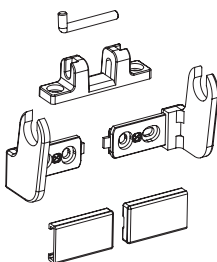

Art. 1123.20

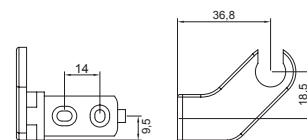
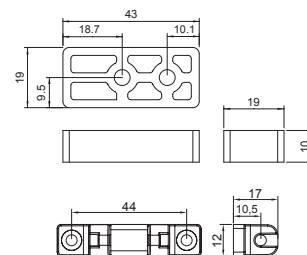
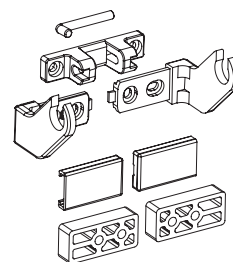

SPORGERE  
 TOP HUNG

Art. 1123.16

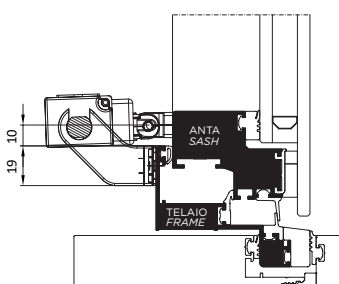

Art. 1123.17

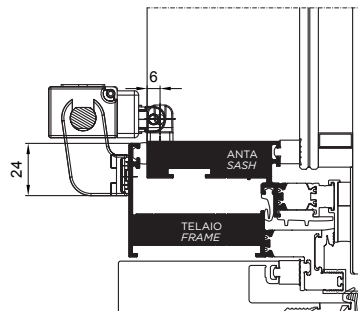

Art. 1123.20

