



# COMFORT 104

## CREMONESI COMFORT RIDOTTA



Cremonesi | Cremone bolts | Cremones | Cremonas



Cassa e manico in alluminio pressofuso; cremagliere, pignone e copricassa in zama zincata; guida e rondella di frizionamento in delrin; viti in acciaio zincato; viti di bloccaggio della cremone su profilo in acciaio inox.



Case and handle in die-cast aluminum; rack, pinion and cover in galvanized zamak; Delrin guide and friction washer; galvanized steel screws; screws for locking cremone bolts on profile in stainless steel.



Caisse et poignée en aluminium moulé sous pression; crémaillères, pignon et couvre-caisse en zamak ingué; guide et rondelle de friction en delrin; vis en acier zingué; vis de blocage de la cremone sur profile en acier inox.



Caja y mango de aluminio fundido a presión; cremalleras, piñón y cobertura de caja de zamak galvanizado; guía y arandela de fricción de delrin; tornillos de acero galvanizado; tornillos de bloqueo de la cremone sobre perfil de acero inox.









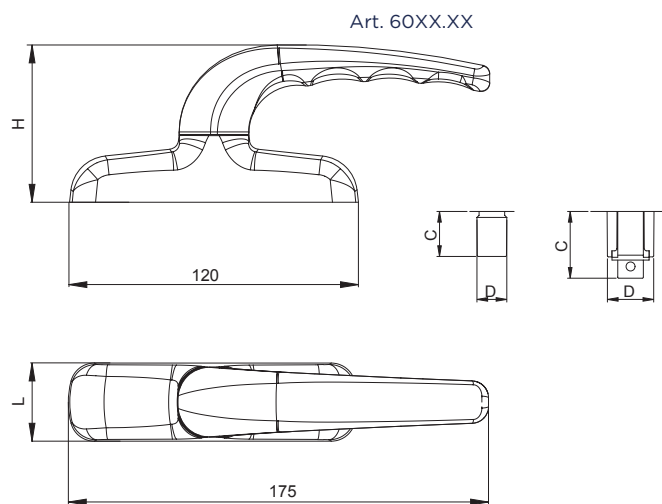
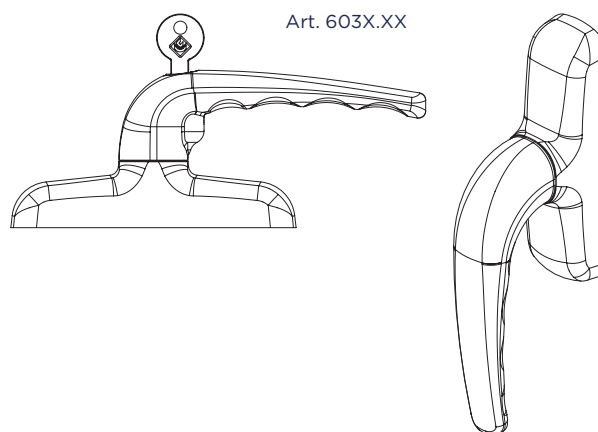
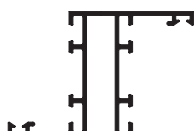
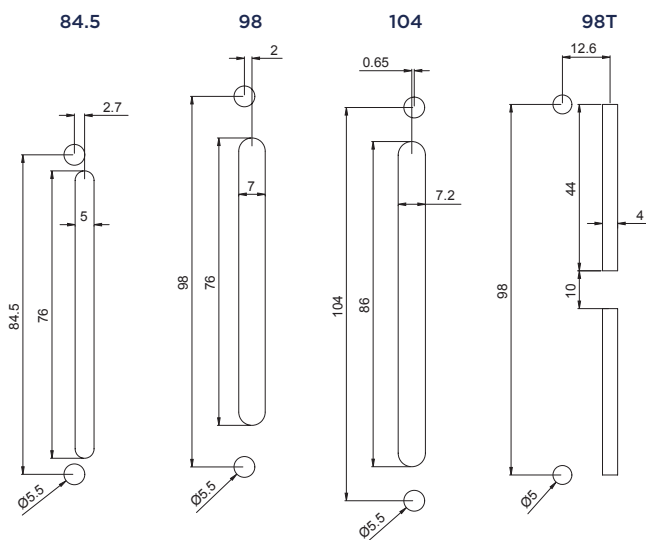









ART.	6005   6005.2   6035				6015   6015.21   6036   6015.41 6036.20   6036.25   6036.23			
Imballo   Package   Conditionnement   Embalaje	20   5 Pz				5 Pz			
Finiture disponibili   Available finishes Finitions disponibles   Acabados disponibles	1	2	3	4	1	2	3	4

\* Le confezioni delle cremonesi e delle martelline sono da 20 pezzi, ad esclusione delle versioni in finiture speciali e vintage "OLD" che sono da 5 pezzi.  
\* Cremone bolts and handles come in packages of 20, except for versions in special and "OLD" vintage finishes that are in packages of 5.

### LAVORAZIONI MACHINING



DESCRIZIONE DESCRIPTION	ART.	TIPO DI CURSORE TYPE OF SLIDER	L	H	C	D	CORSA STROKE	LAVORAZIONE MACHINING
"COMFORT 104" Cremonese con interasse 84,5 - 104 mm "COMFORT 104" Cremonese bolt with inter-axe 84,5 - 104 mm	6005		32.5	65.5	21	14	17	84.5 - 104
"COMFORT 104" Cremonese per serie scorrevole Triall.co "COMFORT 104" Cremonese bolt for sliding series Triall.co	6005.2		32.5	65.5	21	14	17	98
 "COMFORT 104" Cremonese per anta ribalta con anti falsa manovra sulla cremonese, interasse 84,5 - 104 mm "COMFORT 104" Cremonese bolt for Tilt and Turn with anti-false manoeuvre on the cremonese bolt, inter-axe 84,5 - 104mm	6015		32.5	65.5	31	22	17 + 17	104
 "COMFORT 104" Cremonese COMFORT 104 per anta ribalta con anti falsa manovra superiore, con interasse 84,5 - 104 mm "COMFORT 104" Cremonese bolt for Tilt and Turn with upper anti-false manoeuvre, inter-axe 84,5 - 104mm	6015.21		32.5	65.5	21	22	17 + 17	84.5 - 104
COMFORT 104" Cremonese COMFORT 104 con anti falsa manovra superiore, con interasse 84,5 - 104 mm, per scorrevole parallelo SP160 "COMFORT 104" Cremonese bolt with upper anti-false manoeuvre, inter-axe 84,5 - 104mm, for tilt and slide SP160.	6015.41		32.5	65.5	21	22	17 + 17	84.5 - 104
"COMFORT 104" Cremonese COMFORT 104 con cilindro, interasse 84,5 - 104 "COMFORT 104" Cremonese bolt with key, inter-axe 84,5 - 104	6035		32.5	65.5	21	14	17	84.5 - 104
 "COMFORT 104" Cremonese con cilindro, per anta ribalta con anti falsa manovra sulla cremonese   "COMFORT 104" Cremonese bolt with key, for Tilt and Turn with anti-false manoeuvre on the cremonese bolt	6036		32.5	65.5	31	22	17 + 17	104
 "COMFORT LOGICA" Cremonese con cilindro, per anta ribalta logica con anti falsa manovra sulla cremonese "COMFORT LOGICA" Cremonese bolt with key, for Tilt before Turn with anti-false manoeuvre on the cremonese bolt	6036.20		32.5	65.5	31	22	17 + 17	104
 "COMFORT LOGICA" Cremonese con cilindro, per anta ribalta logica con anti falsa manovra superiore "COMFORT LOGICA" Cremonese bolt with key, for Tilt before Turn with upper anti-false manoeuvre	6036.25		32.5	65.5	21	22	17 + 17	104
 "COMFORT LOGICA" Cremonese con cilindro, per anta ribalta logica con anti falsa manovra sulla cremonese "COMFORT LOGICA" Cremonese bolt with key, for Tilt before Turn with anti-false manoeuvre on the cremonese bolt	6036.23		32.5	65.5	31	22	17 + 17	98