



# WEEN

## KIT CATENACCI A LEVA CON PUNTALI ANTI EFFRAZIONE



Kit puntali antieffrazione | Kit push rod anti-burglar |  
Gâche terminale anti-effraction | Puntal anti-robo



Blocchetto di collegamento e incontro in zama, terminale in acciaio inox AISI 316



Connecting block and counterplate in zamak terminal in stainless steel AISI 316



Bloc de connexion et gâche en zamak terminale et en acier inox AISI 316



Bloque de conexión y cerradero en zamak, terminal de acero inoxidable AISI 316

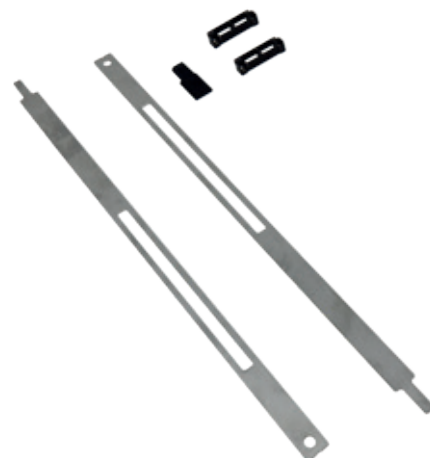

ART.	4533.2			
Imballo   Package   Conditionnement   Embalaje	5 Pz			
Finiture disponibili   Available finishes Finitions disponibles   Acabados disponibles	1	2	3	4

Art. 4533.2

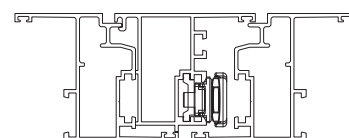
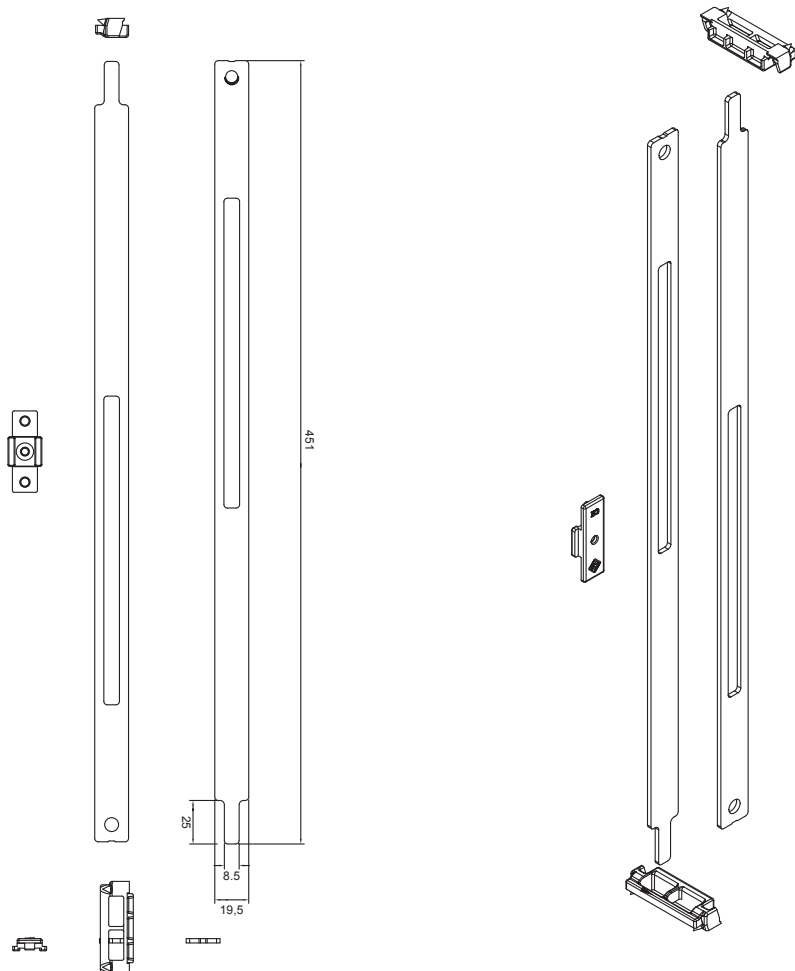

Art.	Nodo Section
4533.2	B04

### LAVORAZIONI MACHINING

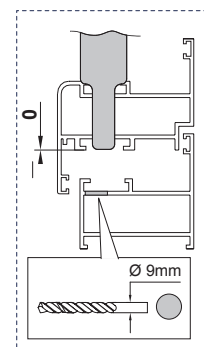



DOPPIA ANTA | DOUBLE SASH

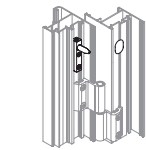
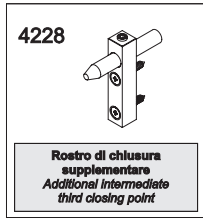
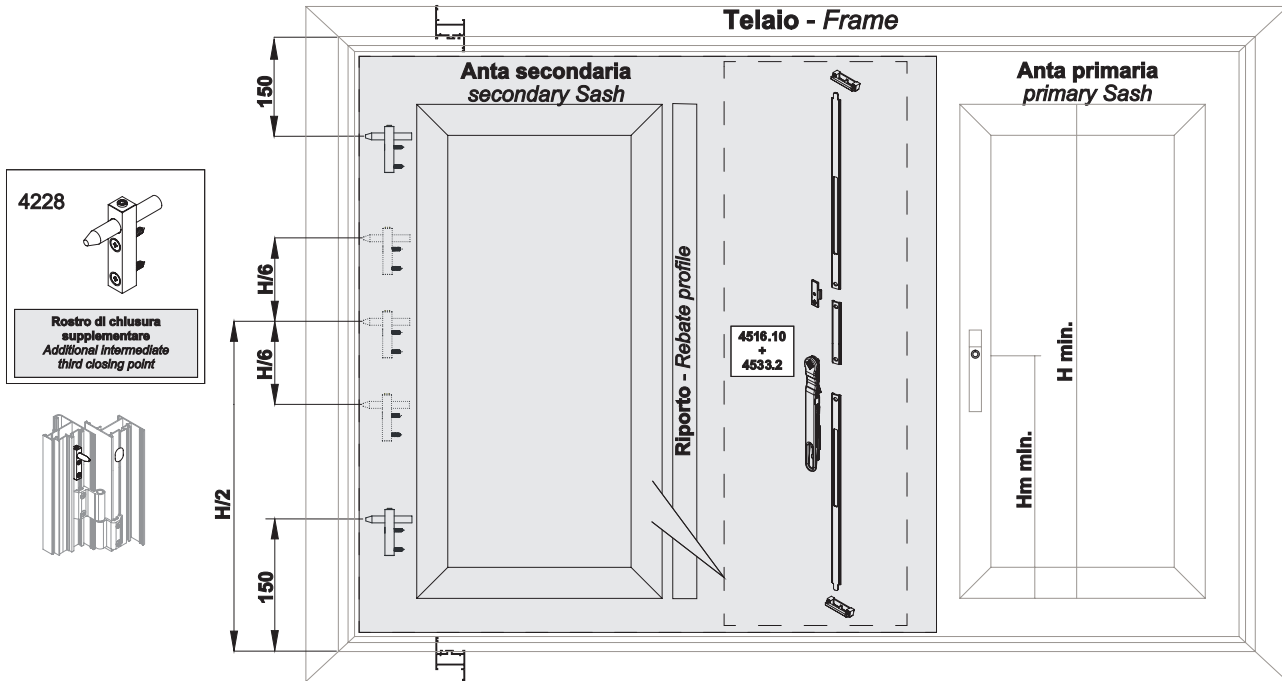

ANTA SECONDARIA | SECONDARY SASH

Configurazioni punti di chiusura aggiuntivi  
Additional locking point configurations

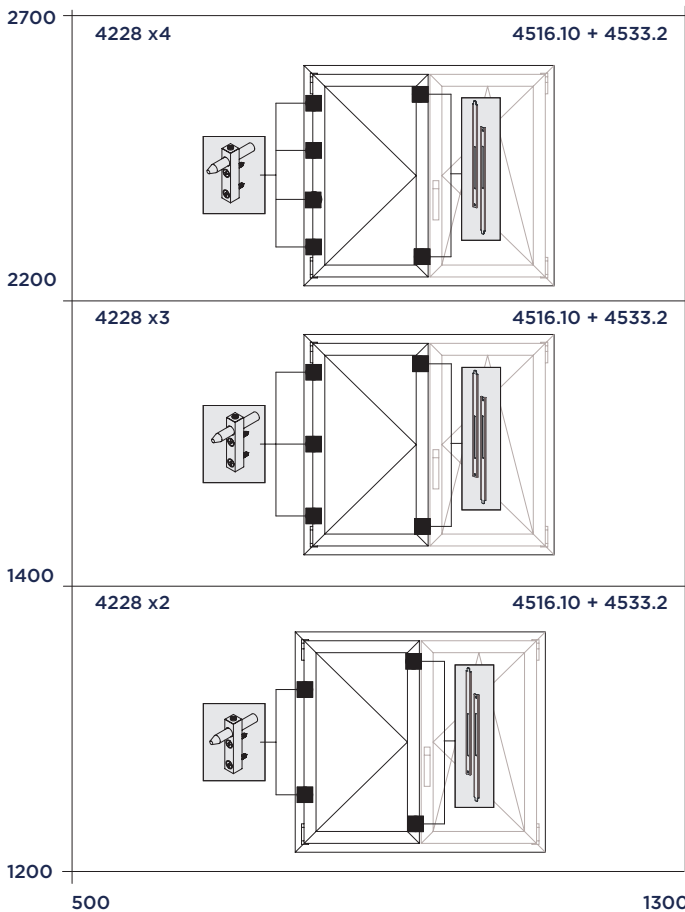

ARTICOLI PER ANTA AFFIANCATA | ARTICLES FOR SECONDARY SASH

WEEN	NODO   SECTION
3421.23	A08

WEEN HIDE 110	NODO   SECTION
3313.71S/D	3313S/D
A08	