



# PENDOLINO TOP

## CARRELLO BILANCIATO REGISTRABILE 100 -180 KG



Carrello bilanciato registrabile | Balanced adjustable roller  
 Chariot equilibre réglable | Rueda regulable



Supporto esterno in nylon, supporto interno in zama zincata; grano, dado e vite di regolazione in acciaio zincato; cuscinetti a sfera o a rulli in acciaio temprato rivestiti in nylon con fibra di vetro.



External support in nylon, internal support in galvanized zamak; setscrew, nut and adjustment screws in galvanized steel; ball or roller bearings in tempered steel covered in nylon with fiberglass.



Support extérieur en nylon, support intérieur en zamak zingué; grain, écrou et vis de réglage en acier zingué; roulements à billes ou à aiguilles en acier trempé revêtus en nylon avec fibre de verre.



Soporte externo de nylon, soporte interno de zamac galvanizado; prisionero, tuerca y tornillo de regulación de acero galvanizado; cojinetes de bolas o de rodillos de acero templado revestidos en nylon con fibra de vidrio.

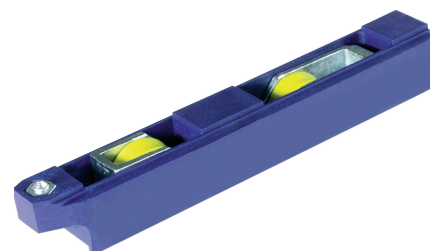

ART.	Tutti   All   Tous   Todos			
Imballo   Package   Conditionnement   Embalaje	60 Pz			
Finiture disponibili   Available finishes Finitions disponibles   Acabados disponibles	1	2	3	4

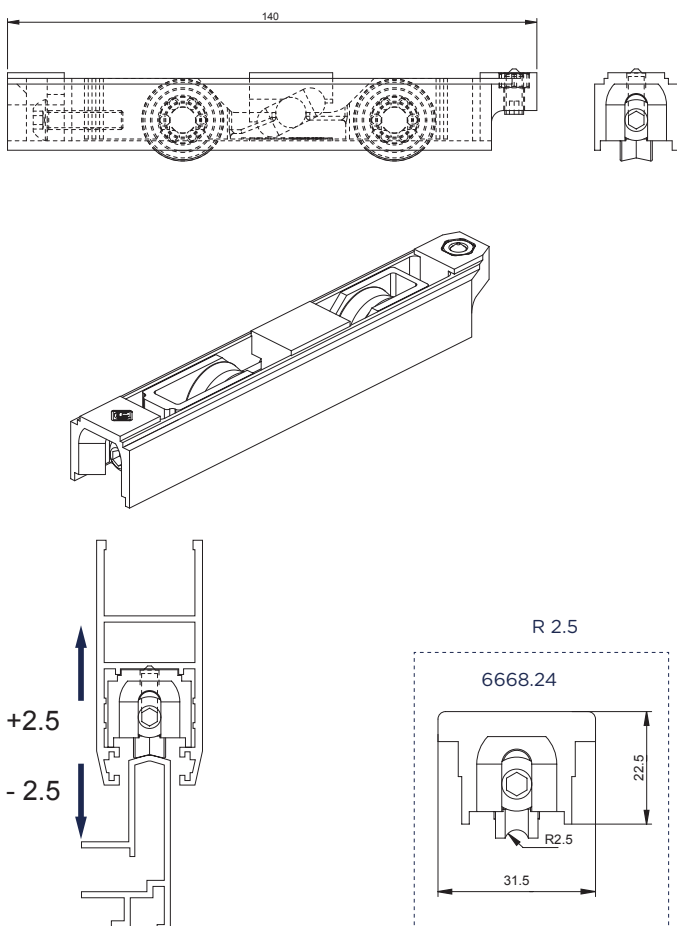

155°

6667 / 6668

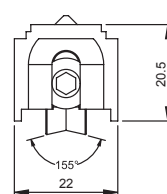

6667.1

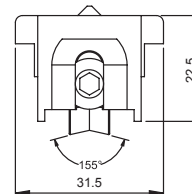

6667.2 / 6668.2

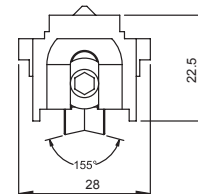

6667.3 / 6668.3

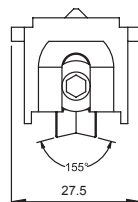

6667.4 / 6668.4

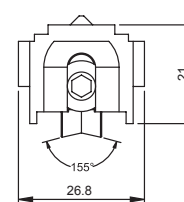

6667.6 / 6668.6

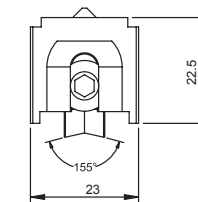

6668.15

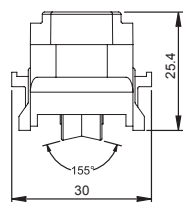

6668.14

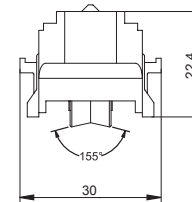

6668.18

