



KARMA

MANIGLIONE ALZANTE CON MANIGLIA DI TRAINO QUADRO 10 MM (AS300)



Maniglione | Pull handle
Barre | Manillón



Manico in alluminio estruso; cassa, copricassa, vaschetta di traino e rotore in zama; boccole antifrimento in delrin, viti e perno in acciaio.



Extruded aluminium handle; body, body cover, pull tray and rotor made of zamak; anti-friction bushings in delrin, steel pin and screws.



Poignée en aluminium extrudé ; caisse, couvre-caisse et rotor en zamak ; bagues anti-friction en delrin, pivot et vis en acier.



Mango de aluminio moldeado a presión; caja, cubrecaja, tirador y rotor de zamak; casquillos antifricción de delrin, tornillos y perno de acero.

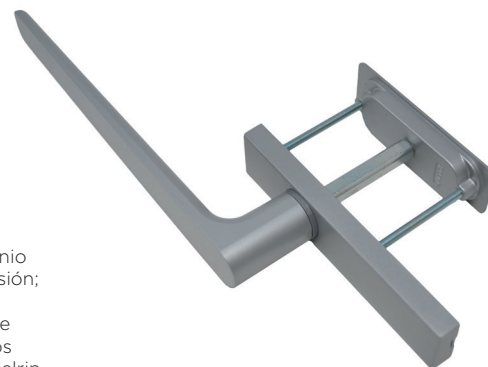

ART.	3081.20 3081.21				6399.11			
Imballo Package Conditionnement Embalaje	2 Pz				20 Pz			
Finiture disponibili Available finishes Finitions disponibles Acabados disponibles	1	2	3	4	1	2	3	4

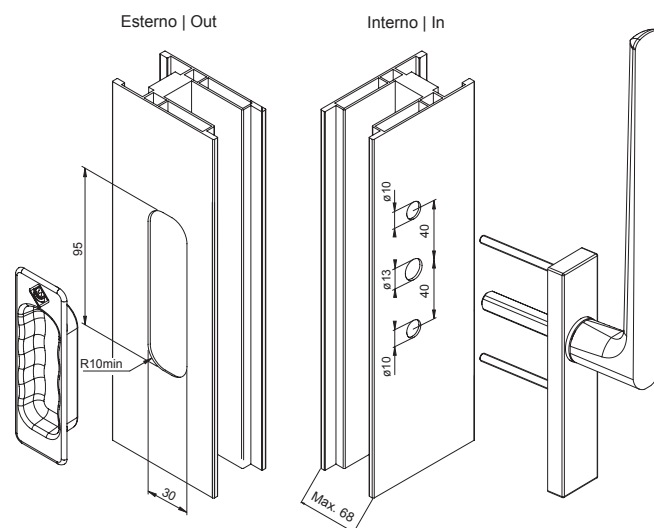
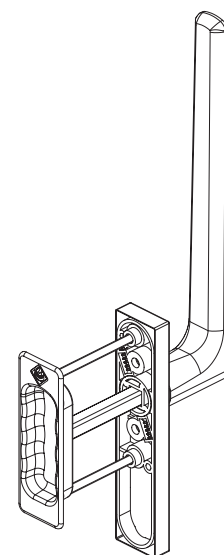
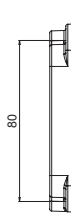
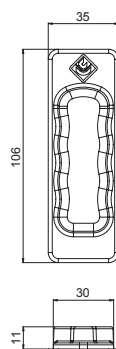
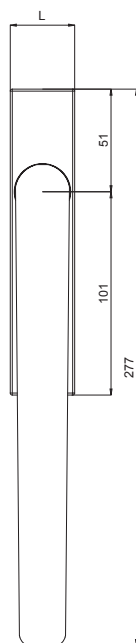
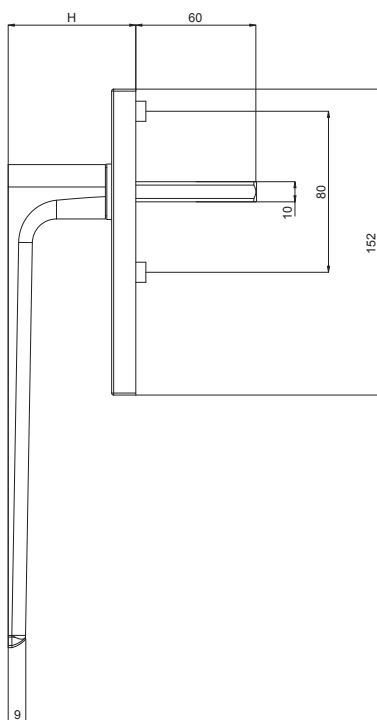

DESCRIZIONE DESCRIPTION	ART.	L	H
KARMA - Maniglione alzante con vaschetta di traino esterna KARMA - Lift and slide handle with external pull handle"	3081.20	32	63.5
KARMA - Maniglione alzante KARMA - Lift and slide handle"	3081.21	32	63.5
Vaschetta di traino esterna External pull handle	6399.11	-	-