

Articoli complementari

Complementary articles

3080.25 Doppio maniglione alzante

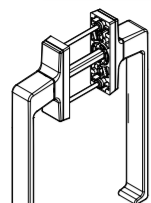

- EN- Double handle lifting
- FR- Double poignée levée
- PL- Podwójny uchwyt podnoszenia
- RU- Двухрукоятный подъемник
- ES- Elevación asa doble

Note:

IT- Utilizzare gli spessori in nylon della giusta misura, tra profilo e cremone.
EN- Use right nylon spacers dimension between handle and cremone.

3080.20 Maniglione alzante + traino

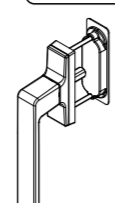

- EN- Handle lifting + trailer
- FR- Poignée de levage + tirant
- PL- Uchwyt podnoszenia+ciąg'n'c
- RU- Рукоятный подъемник + абажур
- ES- Palanca de elevación + tira

Note:

IT- Utilizzare gli spessori in nylon della giusta misura, tra profilo e cremone.
EN- Use right nylon spacers dimension between handle and cremone.

2129.4 Copricilindro

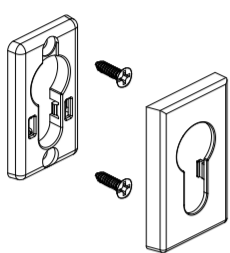

- EN- Cylinder cover
- FR- Kit cache cylindre
- PL- Osłona cylindra
- RU- Эдүүлэгч оёвөг
- ES- Cobertura cilindro

6844.1 Tassello paracolpi

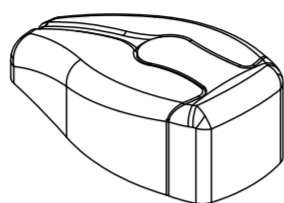

- EN- Door bumper
- FR- Butée de coulissant
- PL- Kotwa zderzak
- RU- Амортизатор
- ES- Amortiguador para correderas

6836.XX Tassello di tenuta centrale superiore

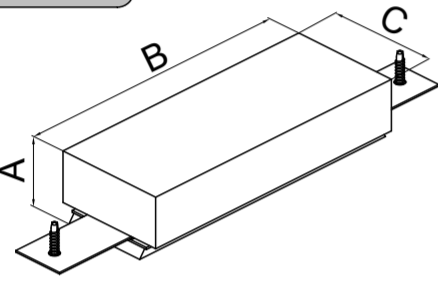

Art.	A	B	C
6836.7	30	140	55
6836.10	30	100	44
6836.12	30	100	26
6836.14	30	100	63

- EN - Block with center seal and brush - hinger
- FR - Patin étancheite centrale avec joint brosse-supérieur
- PL - Końcówka górny szczelniki
- RU - Замок с уплотнителем и щеткой
- ES - Taco retenedor central con cepillo - mayor

6836.XX Tassello di tenuta centrale inferiore

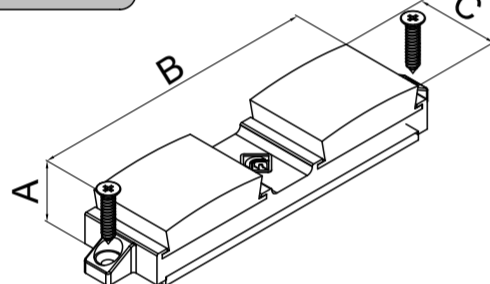

Art.	A	B	C
6836	30	90	33.5
6836.3	25	90	31.5
6836.11	20	90	28.5
6836.13	20	90	63
6836.15	8	100	44
6836.16	11	100	44

- EN - Block with center seal and brush - lower
- FR - Patin étancheite centrale avec joint brosse-inférieur
- PL - Końcówka dolny szczelniki
- RU - Замок с уплотнителем и щеткой
- ES - Taco retenedor central con cepillo - inferior



HARDWARE FOR WINDOWS AND DOORS

<http://www.masteritaly.com>

ALZANTE SCORREVOLE 300/400Kg
LIFT & SLIDE 300/400Kg



Video montaggio disponibile su MASTERTUBE
Video mounting available on MASTERTUBE
Video montage disponible sur MASTERTUBE

AS300

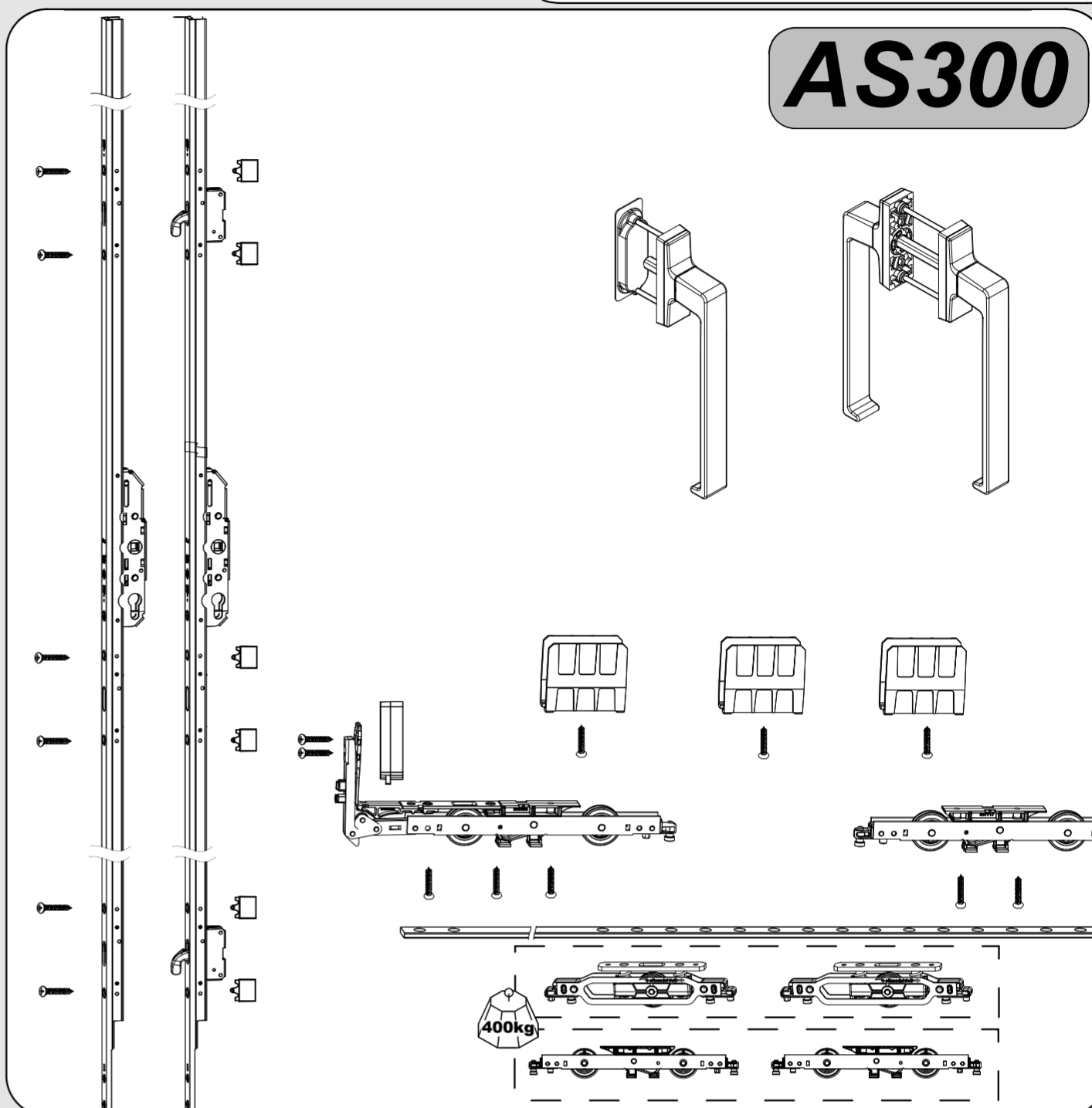

MASTER S.r.l. - I4770 - A3
04/07/2024
La master srl non risponde in alcun modo di possibili inesattezze imputabili ad errori di stampa o di trascrizione dati nel presente foglio.
Master does not bear any responsibility for possible inaccuracies due to printing mistakes or to transcription.

Articoli supplementari

Additional articles

6740.10 Carrelli supplementare

L_{Amin}>1200mm

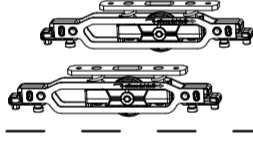

- EN - Additional rollers
- FR - Chariot supplémentaire
- PL - Dodatkowych rolek

6740.11

L_{Amin}>1400mm



- RU - Хаагт амтгэлэгчээр өргөсгөх
- ES - Rueda adicional

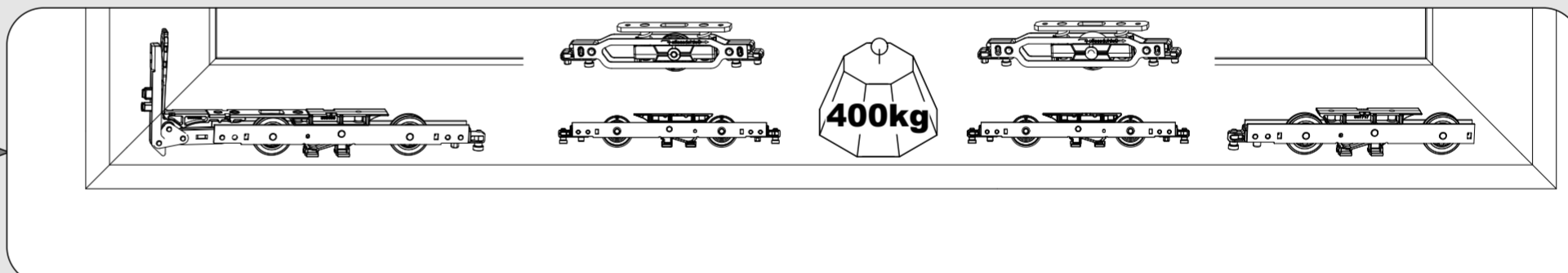

6737.5 Ammortizzatore serratura

150-300 Kg (HA min 1660)

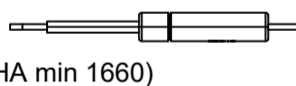

- EN - Damper lock
- FR - Choc serrure
- PL - Szok blokady

6737.6

250-400Kg (HA min 1660)

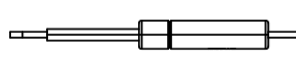

- RU - Чалтэ өтэ
- ES - Choque de bloqueo

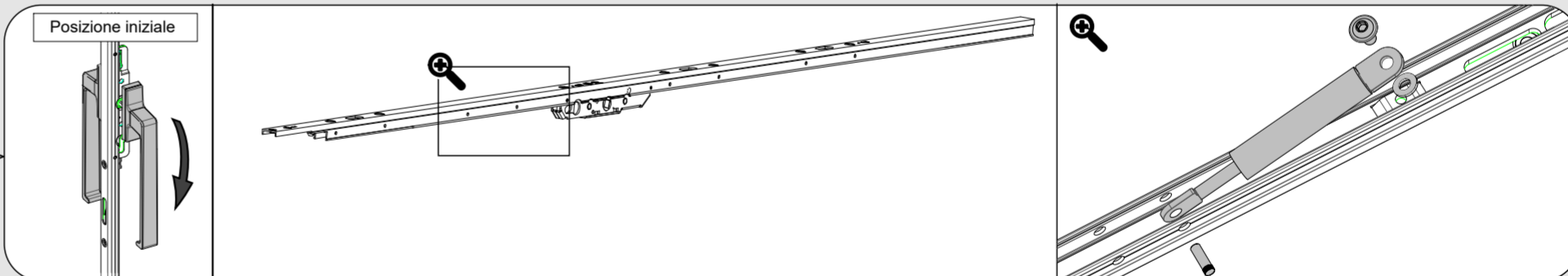

6734.XX Microventilazione

6734.11

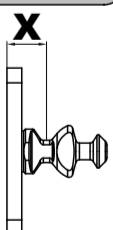

Art.	X
6734.11	12
6734.12	14.5
6734.13	15.5
6734.14	19.5
6734.15	21.5
6734.16	26.5
6734.17	10.5

- EN - Microventilation
- FR - Micro ventilation
- PL - Zestaw mikrowentylacji
- RU - Иагт аэы иэвэгчээр өргөсгөх
- ES - Microventilación

6734.30 Kit spessore chiusure standard

6734.30

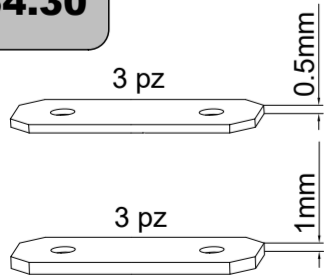

- EN - Standard thickness closures
- FR - Fermetures d'épaisseur standard
- PL - Standardowe grubości zamknięcia
- RU - Ноагааоогуа чаагтүү өргөсгөх
- ES - Cierres de espesor estándar

Specifiche di sistema

System specifications

L anta Min = 720mm
L anta Max = 3385mm

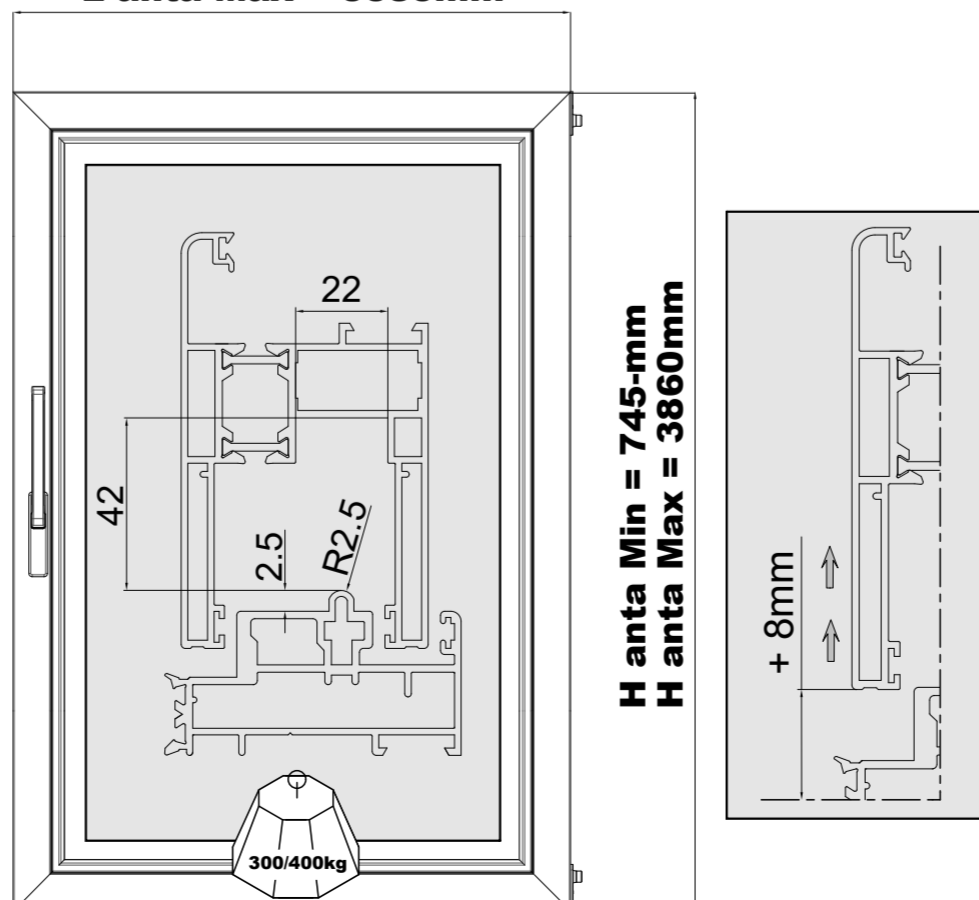

Lavorazioni serratura

Lock machining

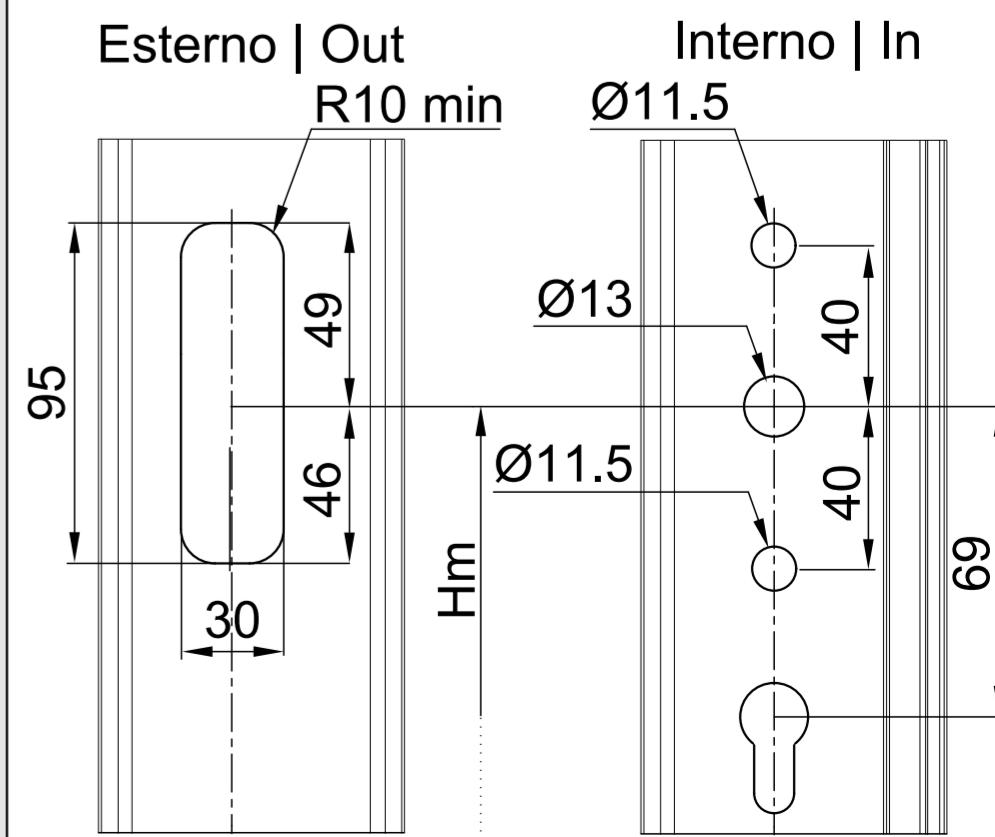

Per eventuali chiarimenti chiedere info al nostro Uff. Tecnico tel. 080.4959823

For other information contact our technical office at: +39.08.04.95.98.23

Aste di chiusura standard

Standard closing rods

Art.	L	H Amin	H Amax	HM	E			
6730.13	1300	745	1360	396.5	27.5			
6730.17	1700	1260	1760	396.5				
6730.21	2100	1660	2160	996.5				
6730.25	2500	2060	2560	996.6				
6730.28	2800	2460	2860	996.5				
6730.33	3300	2760	3360	996.5				
6730.38	3800	3260	3860	996.5				
6731.13	1300	745	1360	396.5				
6731.17	1700	1260	1760	396.5				
6731.21	2100	1660	2160	996.5				
6731.25	2500	2060	2560	996.5				
6731.28	2800	2460	2860	996.5				
6731.33	3300	2760	3360	996.5				
6731.38	3800	3260	3860	996.5				

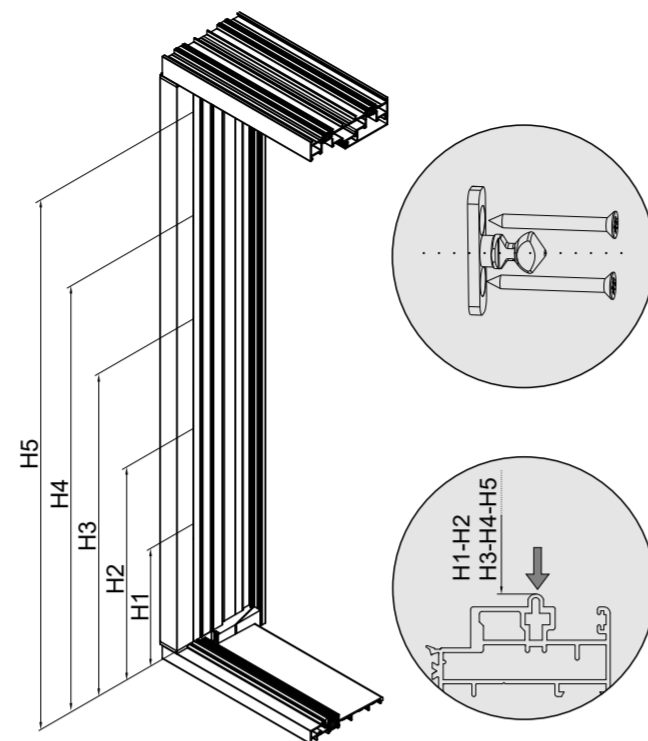

Art.	H1	H2	H3	H4	H5
6730/31.13	195.5	585.5	-	-	-
6730/31.17	195.5	585.5	1100	-	-
6730/31.21	195.5	695.5	1185	1500	-
6730/31.25	195.5	695.5	1185	1900	-
6730/31.28	195.5	695.5	1185	2300	-
6730/31.33	195.5	695.5	1185	1900	2700
6730/31.38	195.5	695.5	1185	2300	3100

6734.X

Chiusure standard

Art.	X
6734.1	10.5
6734.2	12
6734.3	14.5
6734.4	15.5
6734.5	21.5
6734.6	26.5

EN - Standard closures

FR - Fermetures standards

PL - Standardowe zamknięcia

RU - стандартные запоры

ES - Cierres estándar

Indicazioni di montaggio

Mounting instructions

Aste di chiusura con ganci

Closing rods with hooks

Art.	L	H Amin	H Amax	HM	E						
6732.13	1305	735	1360	396.5	27.5						
6732.19	1900	1235	1960	396.5							
6732.25	2500	1835	2560	996.5							
6732.28	2800	2270	2860	996.6							
6732.33	3300	2670	3360	996.5							
6732.38	3800	2670	3860	996.5							
6733.13	1305	735	1360	396.5					37.5		
6733.19	1900	1235	1960	396.5							
6733.25	2500	1835	2560	996.5							
6733.28	2800	2270	2860	996.5							
6733.33	3300	2670	3360	996.5							
6733.38	3800	2670	3860	996.5							

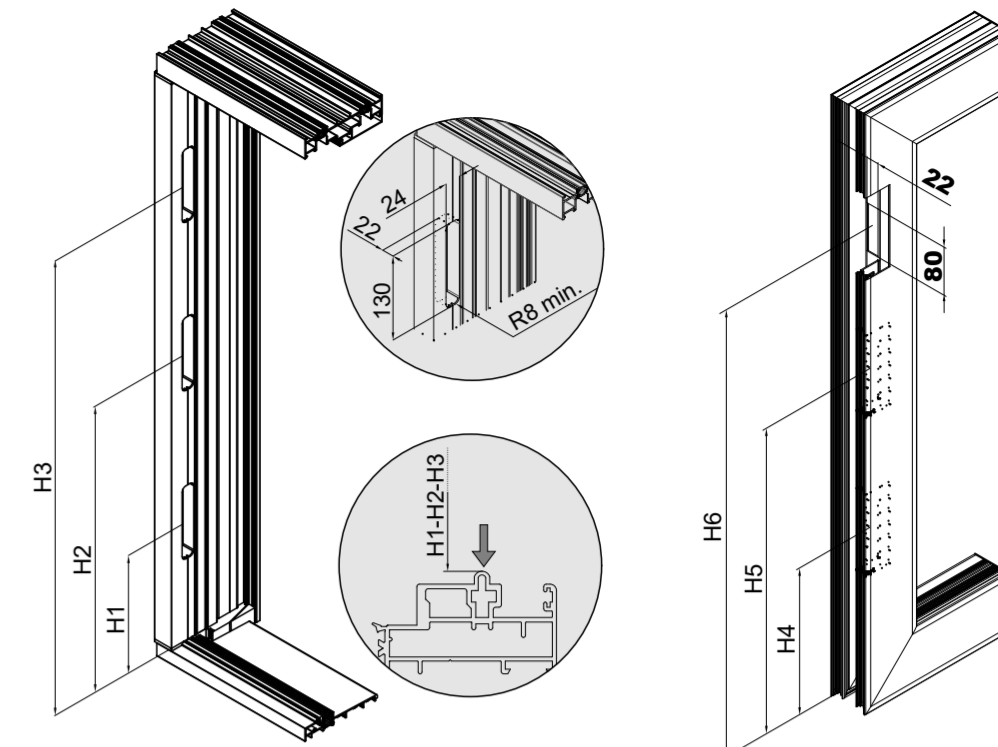

6735

Chiusure per ganci

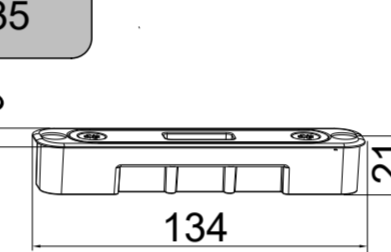

EN - Closures for hooks

FR - Fermetures pour crochets

PL - Zamknięcia do haków

RU - запоры с крючками

ES - Los cierres de los ganchos

Art.	H1	H2	H3
6732/33.13	212	582	-
6732/33.19	212	1082	-
6732/33.25	212	1678	-
6732/33.28	212	1210	2110
6732/33.33	212	1410	2510
6732/33.38	212	1410	2510

H4	H5	H6
222	594	-
222	1094	-
222	1690	-
222	1222	2122
222	1422	2522
222	1422	2522

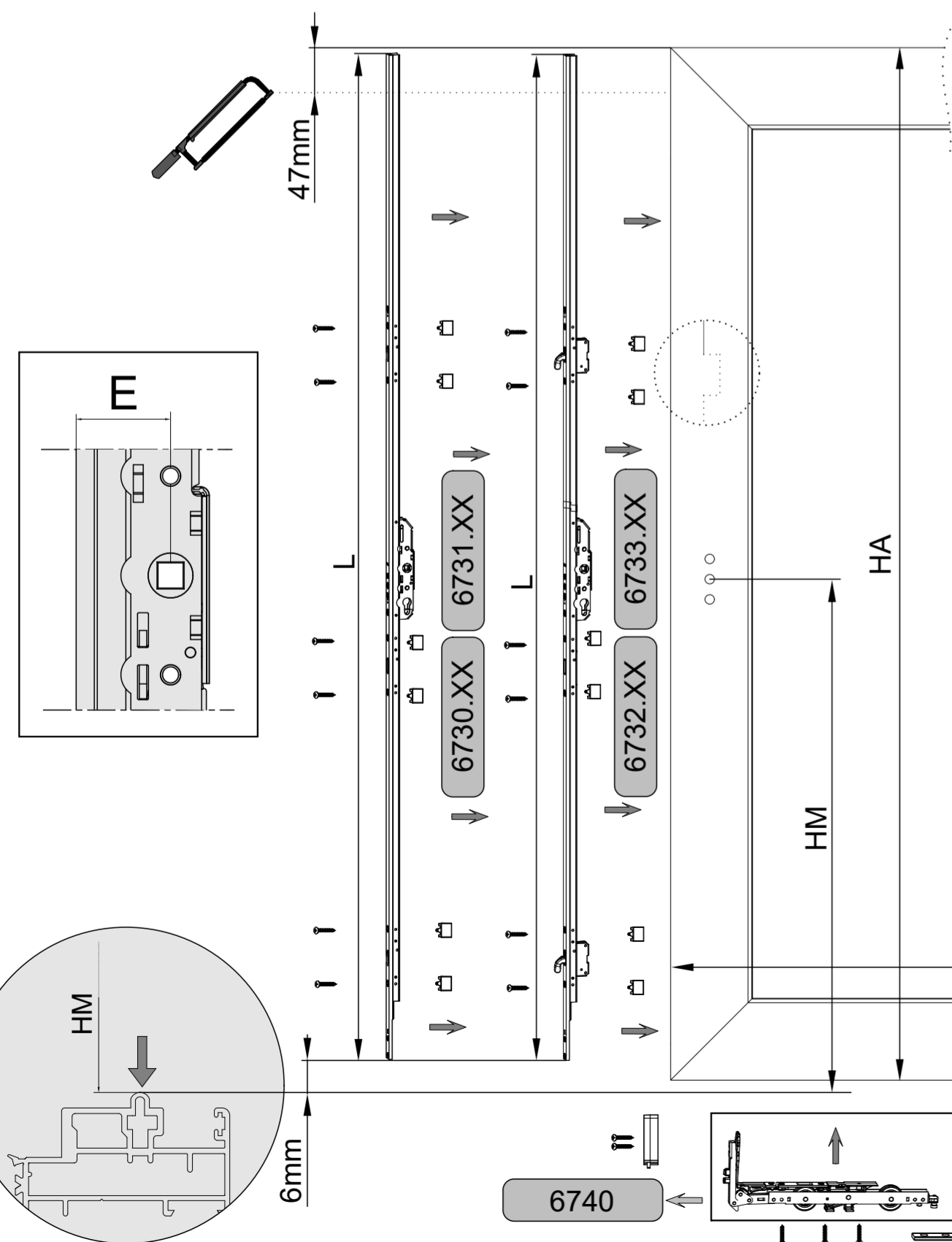

6736.XX

Spessori aste

Art.	X	Art.	X
6736.4	4	6736.20	20.5
6736.10	10	6736.22	22
6736.14	14	6736.25	25.5
6736.16	16.5	6736.30	30
6736.18	18.5	6736.32	32
		6736.36	36

EN - Auction thicknesses

FR - épaisseurs d'enchères

PL - Grubość aukcja

RU - толщина аукцион

ES - Espesores de subastas

6742.XX

Spessori carrelli - verticali

Art.	X	Art.	X
6742.10	10	6742.25	25.5
6742.14	14	6742.26	26.5
6742.16	16.5	6742.29	29
6742.18	18.5	6742.30	30
6742.20	20.5	6742.32	32
6742.22	22	6742.36	36

EN - Trucks thicknesses - Vertical

FR - Camions épaisseurs - Vertical

PL - Ciężarówki grubości - Pionowy

RU - толщина вагонов - вертикаль

ES - Camiones espesores - Vertical

6742A.XX

Spessori carrelli - orizzontali

Art.	X
6742A.3	3
6742A.5	5
6742A.6	6
6742A.8	8
6742A.10	10

EN - Trucks thicknesses - Horizontal

FR - Camions épaisseurs - Horizontal

PL - Ciężarówki grubości - Poziomy

RU - толщина вагонов - горизонталь

ES - Camiones espesores - Horizontal

6741.X

Collegamento carrelli

Art.	Kg	X
6740	300	LA - 605
6740.10	400	LA - 1080
6740.11	400	LA - 1224

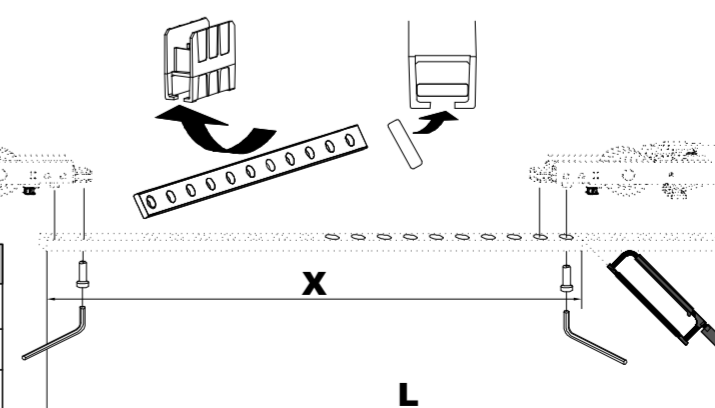

Art.	LAmin	LAmax	L
6741.1	720	1300	692
6741.2	1225	1800	1196
6741.3	1730	2305	1700
6741.4	2235	2810	2204
6741.5	2740	3385	2708

EN - Rod of connecting rollers

FR - Jonction chariots

PL - Rod podłączenia rolki

RU - штанга соединения роликов

ES - Varilla de conexión de rodillos