



ACCESSORI PER SERRAMENTI PROGETTATI PER DURARE
SCHEDA TECNICA DI MONTAGGIO



Karma Doppie/Mezze Maniglie Minimali

<http://www.masteritaly.com>

MANIGLIE CON PERNO REGOLABILE E DESIGN INTERCAMBIABILE

A309x.x

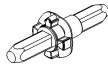
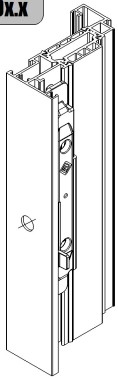

A3090.x

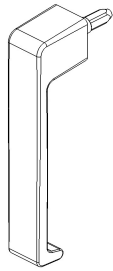

A3091.x

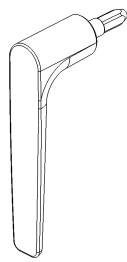

A3091.xD

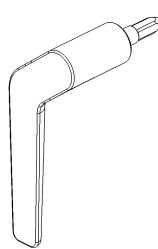

A3091.xS

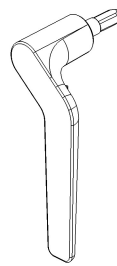

Video montaggio disponibile su MASTERTUBE
Video mounting available on MASTERTUBE
Video montage disponible sur MASTERTUBE

A309x.2x

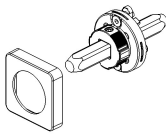
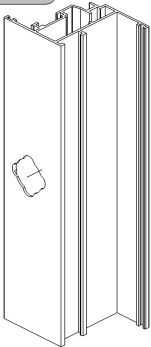

A3090.2x

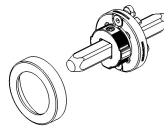
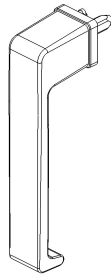

A3091.2x

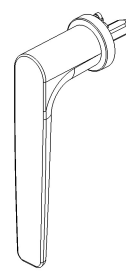

A3091.2xD

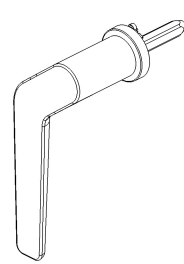

A3091.2xS



A309x.3x

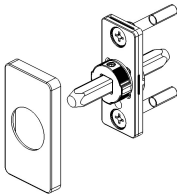
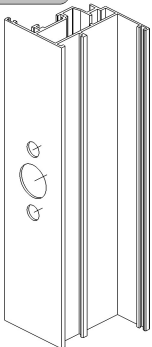

A3090.3x

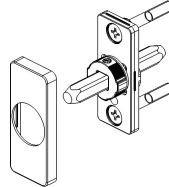
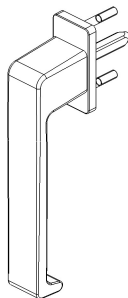

A3091.3x

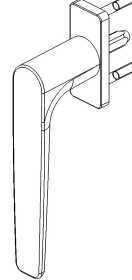

A3091.3xD

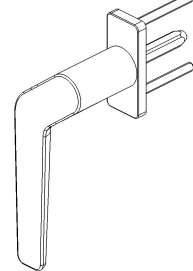

A3091.3xS

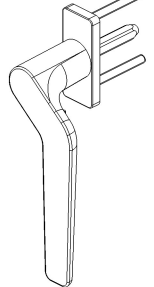

A305x.XX + A2129.10

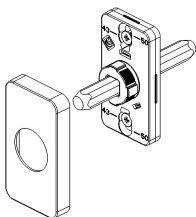
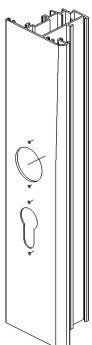

A3050

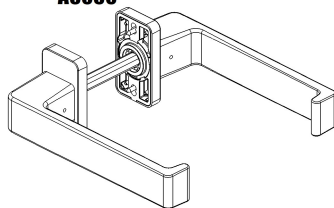

A3051

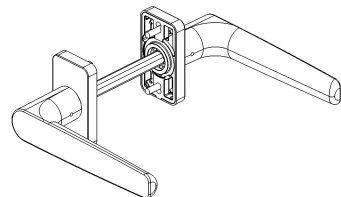

A3050.10

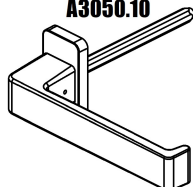



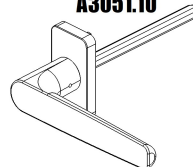

A3051.10

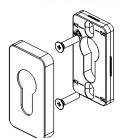

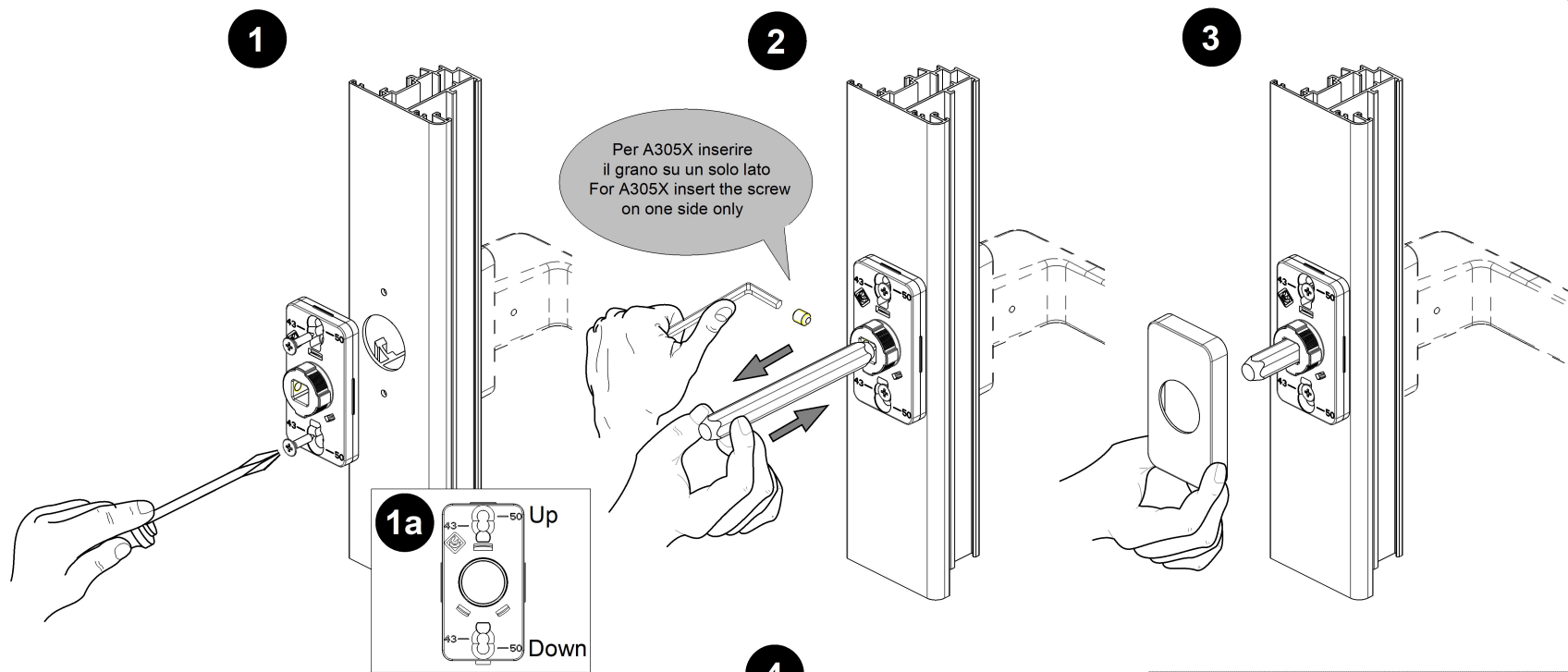
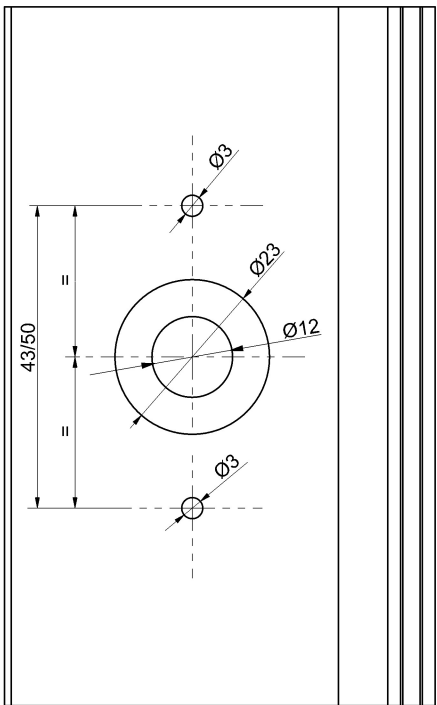
A2129.10

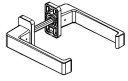
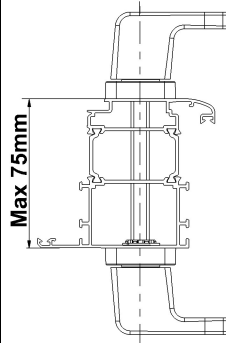
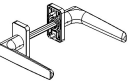
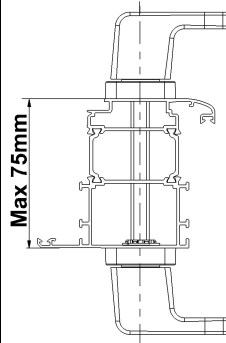

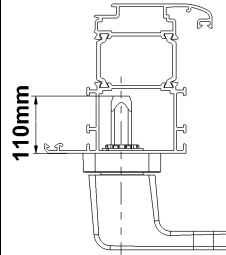

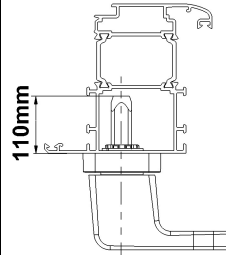
DESCRIZIONE	ARTICOLO	- A -
 Doppia Maniglia Minimale - linea Italia Minimal design double handle "Italia"	3050	 Max 75mm
 Doppia Maniglia Minimale Minimal design double handle	3051	 Max 75mm
 Mezza Maniglia Minimale - linea Italia Minimal design single handle "Italia"	3050.10	 110mm
 Mezza Maniglia Minimale Minimal design single handle	3051.10	 110mm

