

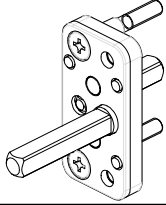

SCHEDA TECNICA DI MONTAGGIO

# Deviatore

<http://www.masteritaly.com>



**3632**

**DEVIATORE QUADRO MANIGLIA**  
DIVERTER SQUARE HANDLE

Altri accessori  
Other accessories

**3630.20**



CE  
con AFM

**3630.30**



CE  
senza AFM

**3631.20**



ERRE  
con AFM

**3631.30**



ERRE  
senza AFM

## Lavorazione anta / Sash machining

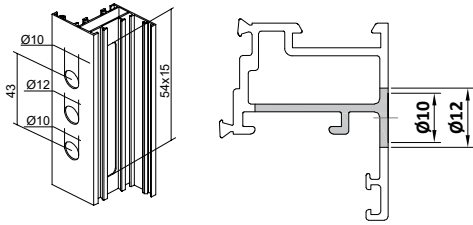

## Montaggio / Assembly

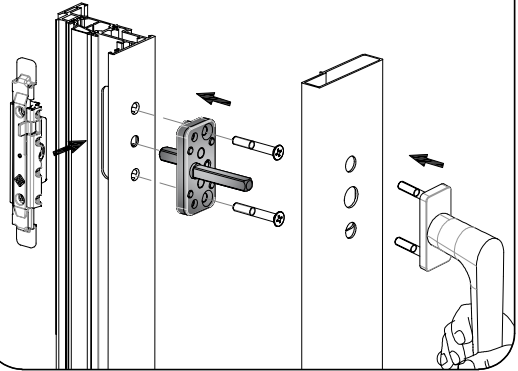

## Lavorazione cartella di centraggio / Centering cover machining

**3090.2x**



**3091.2x**



**3090.3x**

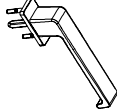

**3091.3x**

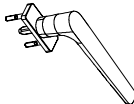

**3070**



**3072**

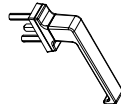

**3100**

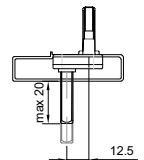
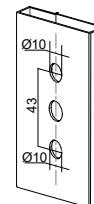
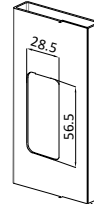
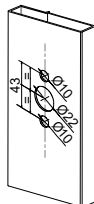
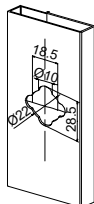
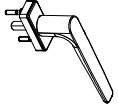

**Non tagliare il perno del deviatore**  
Don't cut the pin of diverter

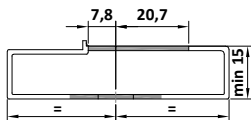

**Tagliare il perno del deviatore**  
Cut the pin of diverter

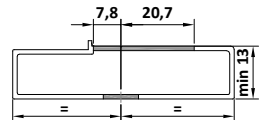

**Rimuovere il perno dalla maniglia**  
Remove the pin from the handle  
**Tagliare le viti delle maniglie**  
Cut the screws supplied with handle