

Deviatore

<http://www.masteritaly.com>

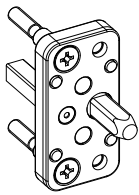

3632.1
DEVIATORE QUADRO MANIGLIA
DIVERTER SQUARE HANDLE

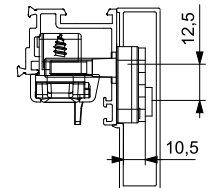
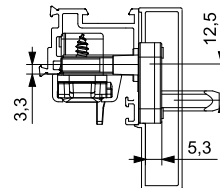
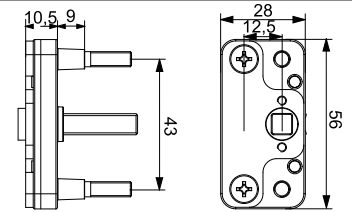
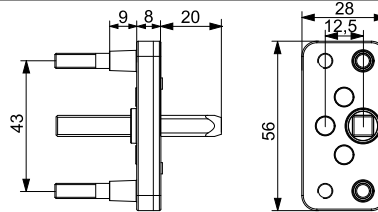
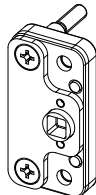

Montaggio / Assembly 3632.1

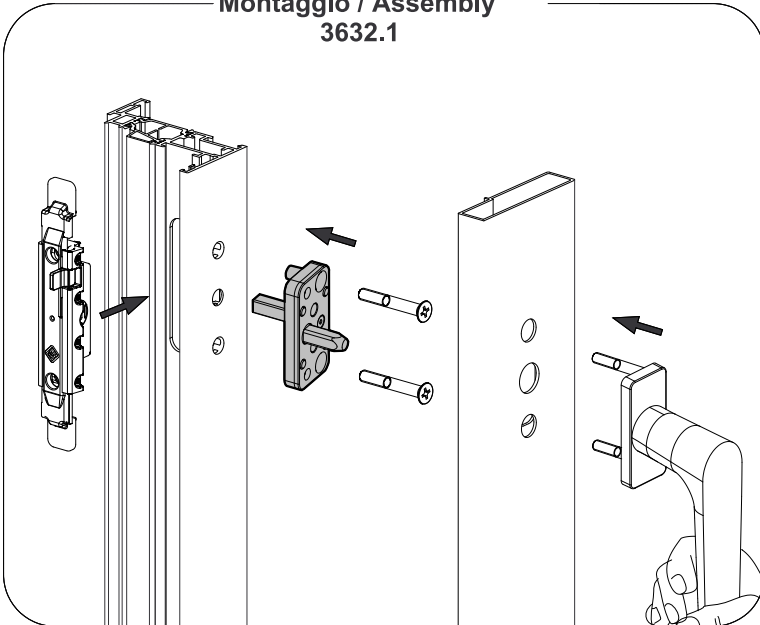

Montaggio / Assembly 3632.2

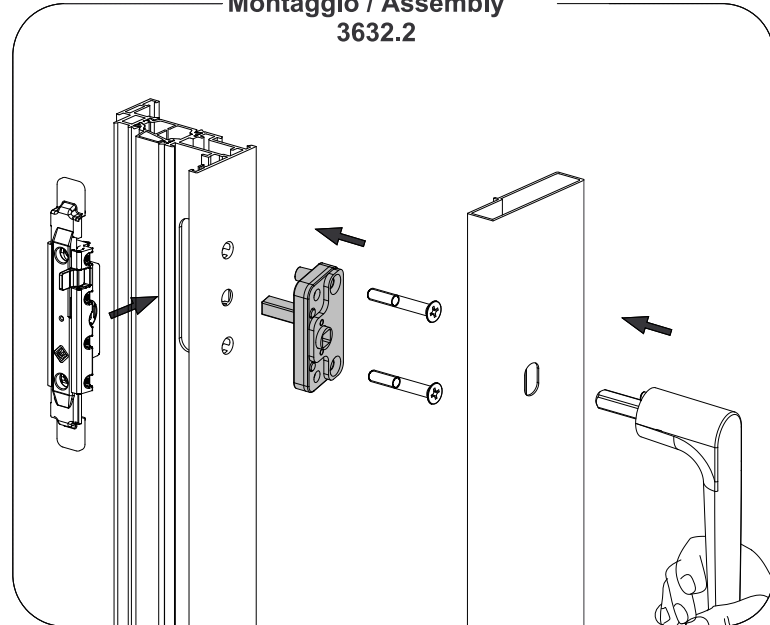

Altri accessori Other accessories

3630.20

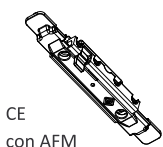

CE
con AFM

3630.30

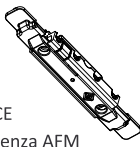

CE
senza AFM

3631.20

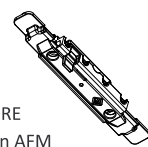

ERRE
con AFM

3631.30

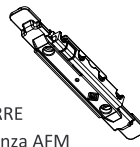

ERRE
senza AFM

Lavorazione anta / Sash machining

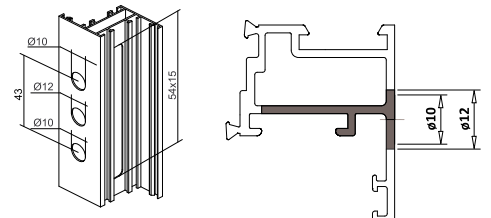

Lavorazione cartella di centraggio / Centering cover machining

3070

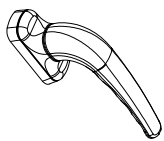

3072

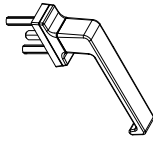

3100

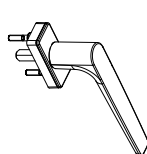

3091.A

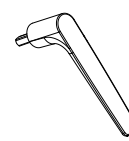

Utilizzabile solo con 3632.2
Can only be used with 3632.2

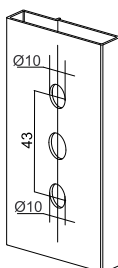
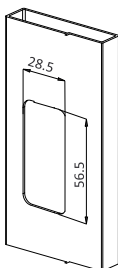

Rimuovere il perno dalla maniglia con 3632.1
Remove pin from the handle with 3632.1

Tagliare il perno della maniglia con 3632.2
Cut the handle pin with

Tagliare il perno della maniglia
Cut the handle pin

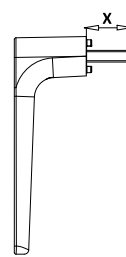

X = H - 8.5mm

