

SCHEDA TECNICA DI MONTAGGIO

"KARMA" 20°

<http://www.masteritaly.com>

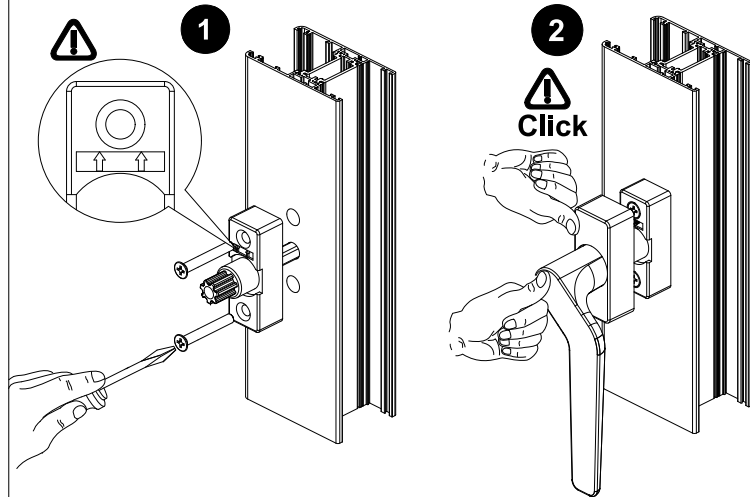

3

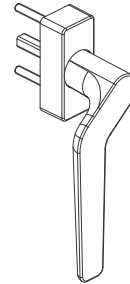
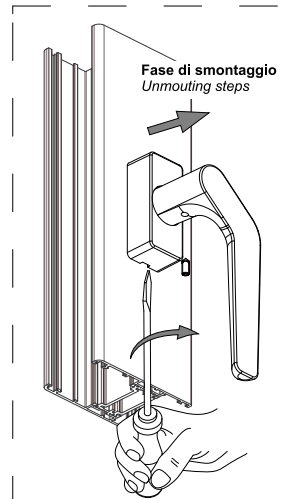
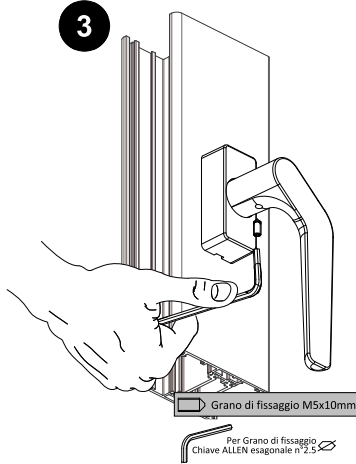

A3107.D

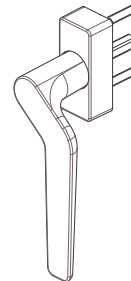
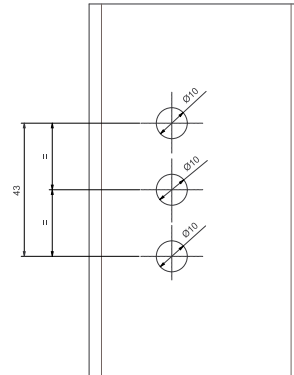

A3107.S

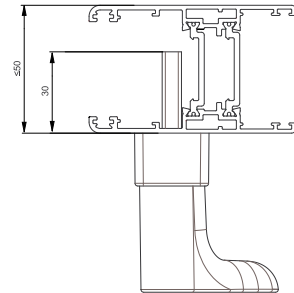

Per eventuali chiarimenti
chiedere info al nostro
UFF. Tecnico
tel. 080.4959823

 **L'esperto
Consiglia:**