



TOP SPIN

CERNIERA A PETTINE IN ALLUMINIO ESTRUSO



Cerniera a pettine in alluminio estruso | Comb hinge in extruded aluminium | Paumelle a peigne en aluminium extrudé | Bisagras de tres alas de aluminio extruido



Cerniera lato telaio e lato anta in alluminio estruso, piastrine in zama, boccole e tappini in nylon, viti, perno grano in acciaio inox.



Frame side and shutter side in extruded aluminium, zamak plates, nylon bushings and caps, stainless steel screws and pin.



Paumelle côté dormant et côté ouvrant en aluminium extrudé, plaques en zamak, bagues et bouchons en nylon, vis et pivot en acier inox.



Bisagra del lado del marco y de la hoja de aluminio extruido, placas de zamak, casquillos y tapones de nylon, tornillos y perno de acero inox.



| ART. | TUTTI ALL TOUS TODOS |
|---|-------------------------------|
| Imballo Package Conditionnement Embalaje | 10 PZ |
| Finiture disponibili Available finishes Finitions disponibles Acabados disponibles | 1 2 3 4 |

Art. 3420.71 | 3420.72 | 3421.72

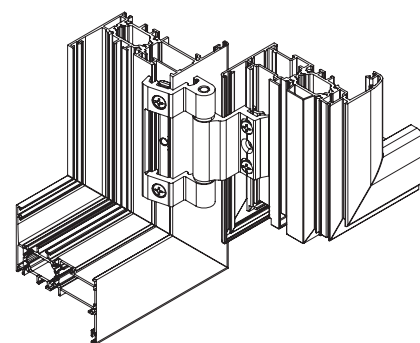
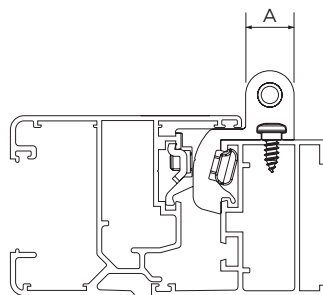
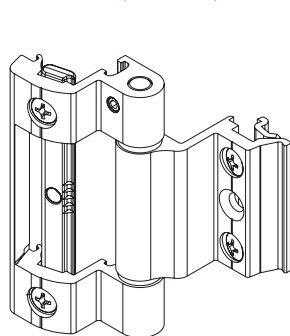

| DESCRIZIONE DESCRIPTION | ART | NODO SECTION | A |
|---|---------|-----------------|----|
| Cerniera a pettine in alluminio estruso Comb hinge in extruded aluminium | 3420.71 | A03 | 15 |
| Cerniera a pettine in alluminio estruso Comb hinge in extruded aluminium | 3420.72 | A01 - A05 | 15 |
| Cerniera a pettine in alluminio estruso Comb hinge in extruded aluminium | 3421.72 | A08 | 15 |

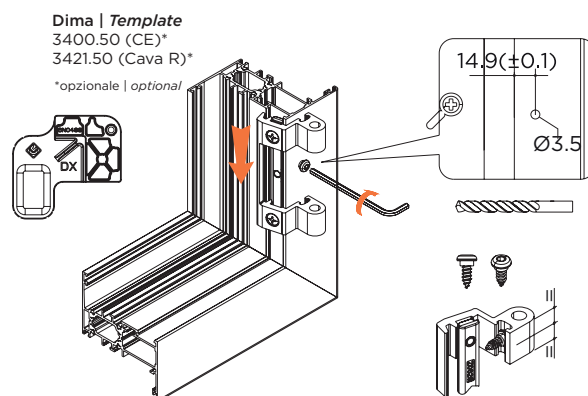



BATTENTE CASEMENT

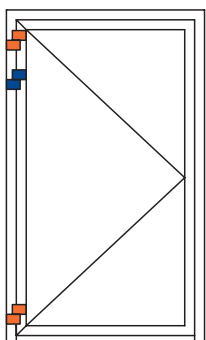

| | | | | | | | | | | |
|---|------|------|------|------|------|------|------|------|------|------|
| | 2800 | 100% | 100% | 100% | 100% | 100% | 100% | 100% | 100% | 100% |
| | 2700 | 100% | 100% | 100% | 100% | 100% | 100% | 100% | 100% | 100% |
| | 2600 | 100% | 100% | 100% | 100% | 100% | 100% | 100% | 100% | 100% |
| | 2500 | 100% | 100% | 100% | 100% | 100% | 100% | 100% | 100% | 100% |
| | 2400 | 100% | 100% | 100% | 100% | 100% | 100% | 100% | 100% | 100% |
| | 2300 | 100% | 100% | 100% | 100% | 100% | 100% | 100% | 100% | 100% |
| | 2200 | 100% | 100% | 100% | 100% | 100% | 100% | 100% | 97% | |
| | 2100 | 100% | 100% | 100% | 100% | 100% | 100% | 100% | 90% | |
| | 2000 | 100% | 100% | 100% | 100% | 100% | 100% | 94% | 83% | |
| | 1900 | 100% | 100% | 100% | 100% | 100% | 98% | 86% | 76% | |
| | 1800 | 100% | 100% | 100% | 100% | 100% | 90% | 78% | 69% | |
| | 1700 | 100% | 100% | 100% | 100% | 100% | 95% | 82% | 71% | 61% |
| | 1600 | 100% | 100% | 100% | 100% | 100% | 85% | 73% | 63% | 54% |
| H | 1500 | 100% | 100% | 100% | 100% | 90% | 76% | 65% | 55% | N.D. |
| | 1400 | 100% | 100% | 100% | 96% | 80% | 67% | 57% | N.D. | N.D. |
| | 1300 | 100% | 100% | 100% | 84% | 70% | 58% | N.D. | N.D. | N.D. |
| | 1200 | 100% | 100% | 90% | 73% | 60% | N.D. | N.D. | N.D. | N.D. |
| | 1100 | 100% | 97% | 78% | 62% | 50% | N.D. | N.D. | N.D. | N.D. |
| | 1000 | 100% | 83% | 65% | 51% | N.D. | N.D. | N.D. | N.D. | N.D. |
| | | 600 | 700 | 800 | 900 | 1000 | 1100 | 1200 | 1300 | 1400 |

L

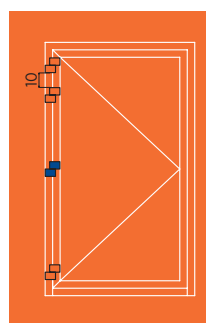
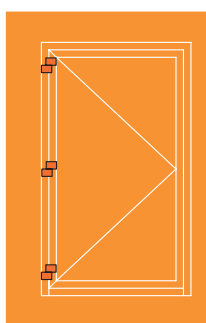
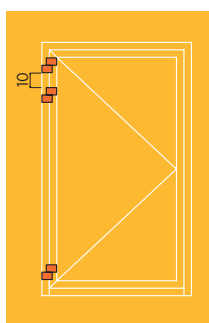
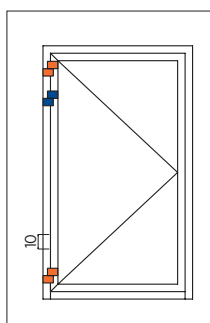

| ART. | | PORTATA LOAD CAPACITY |
|-------------------------------|---|--------------------------|
| 3420.71 3420.72 3421.72 | | 100% = 80 Kg |
| 3420.71 3420.72 3421.72 | + | 100% = 120 Kg |

VASISTAS PESANTE HEAVY BOTTOM HINGE WINDOW

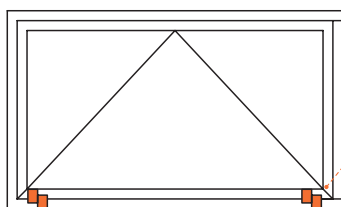

Art. 352X.33
Kit sostegno anta
Shutter support kit

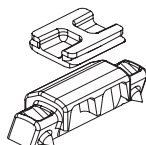

| | | | | | | |
|---|------|-----|------|------|------|------|
| | 3000 | 72% | 80% | 80% | 80% | 100% |
| | 2000 | 72% | 80% | 80% | 80% | 100% |
| | 1600 | 60% | 80% | 80% | 80% | 100% |
| | 1100 | 60% | 80% | 80% | 80% | 100% |
| | 500 | 48% | 48% | 60% | 60% | 74% |
| H | | 500 | 1100 | 1600 | 2000 | 2500 |

L

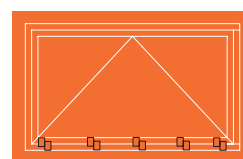
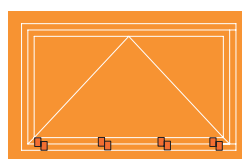
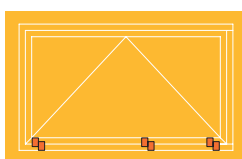
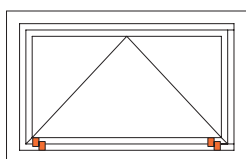

| ART. | * | PORTATA LOAD CAPACITY |
|--------------------|---|--------------------------|
| 3420.71 3420.72 | + | 100% = 250 Kg |
| 3421.72 | + | 100% = 140 Kg |

* OBBLIGATORIO
MANDATORY



SPORGERE PROJECTING OPENING

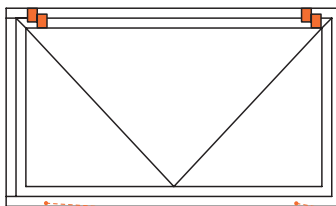

Art. 352X.33
Kit sostegno anta
Shutter support kit

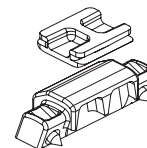

| | | | | | | | | | | | | | | | | | | | |
|---|------|------|------|------|------|------|------|------|------|------|------|------|------|------|------|------|------|------|------|
| H | 2000 | 100% | 100% | 100% | 100% | 100% | 100% | 100% | 100% | 100% | 100% | 100% | 100% | 100% | 100% | 100% | 100% | 100% | 100% |
| | 1900 | 100% | 100% | 100% | 100% | 100% | 100% | 100% | 100% | 100% | 100% | 100% | 100% | 100% | 100% | 100% | 100% | 100% | 100% |
| | 1800 | 100% | 100% | 100% | 100% | 100% | 100% | 100% | 100% | 100% | 100% | 100% | 100% | 100% | 100% | 100% | 100% | 100% | 100% |
| | 1700 | 100% | 100% | 100% | 100% | 100% | 100% | 100% | 100% | 100% | 100% | 100% | 100% | 100% | 100% | 100% | 100% | 100% | 100% |
| | 1600 | 100% | 100% | 100% | 100% | 100% | 100% | 100% | 100% | 100% | 100% | 100% | 100% | 100% | 100% | 100% | 100% | 100% | 100% |
| | 1500 | 100% | 100% | 100% | 100% | 100% | 100% | 100% | 100% | 100% | 100% | 100% | 100% | 100% | 100% | 100% | 100% | 100% | 100% |
| | 1400 | 100% | 100% | 100% | 100% | 100% | 100% | 100% | 100% | 100% | 100% | 100% | 100% | 100% | 100% | 100% | 100% | 100% | 100% |
| | 1300 | 100% | 100% | 100% | 100% | 100% | 100% | 100% | 100% | 100% | 100% | 100% | 100% | 100% | 100% | 100% | 100% | 100% | 100% |
| | 1200 | 100% | 100% | 100% | 100% | 100% | 100% | 100% | 100% | 100% | 100% | 100% | 100% | 100% | 100% | 100% | 100% | 100% | 100% |
| | 1100 | 100% | 100% | 100% | 100% | 100% | 100% | 100% | 100% | 100% | 100% | 100% | 100% | 100% | 100% | 100% | 100% | 100% | 100% |
| | 1000 | 100% | 100% | 100% | 100% | 100% | 100% | 100% | 100% | 100% | 100% | 100% | 100% | 100% | 100% | 100% | 100% | 100% | 100% |
| | 900 | 100% | 100% | 100% | 100% | 100% | 100% | 100% | 100% | 100% | 100% | 100% | 100% | 100% | 100% | 100% | 100% | 100% | 100% |
| | 800 | 100% | 100% | 100% | 100% | 100% | 100% | 100% | 100% | 100% | 100% | 100% | 100% | 100% | 100% | 100% | N.D. | N.D. | N.D. |
| | 700 | 100% | 100% | 100% | 100% | 100% | 100% | 100% | 100% | 100% | 100% | 100% | 100% | 100% | N.D. | N.D. | N.D. | N.D. | N.D. |
| | 600 | 100% | 100% | 100% | 100% | 100% | 100% | 100% | 100% | 100% | 100% | N.D. | N.D. | N.D. | N.D. | N.D. | N.D. | N.D. | N.D. |
| | 500 | 100% | 100% | 100% | 100% | 100% | 100% | 100% | 100% | N.D. | N.D. | N.D. | N.D. | N.D. | N.D. | N.D. | N.D. | N.D. | N.D. |
| | 400 | 100% | 100% | 100% | 100% | 100% | N.D. | N.D. | N.D. | N.D. | N.D. | N.D. | N.D. | N.D. | N.D. | N.D. | N.D. | N.D. | N.D. |
| | 300 | 100% | 100% | 100% | 100% | N.D. | N.D. | N.D. | N.D. | N.D. | N.D. | N.D. | N.D. | N.D. | N.D. | N.D. | N.D. | N.D. | N.D. |
| | | | 300 | 400 | 500 | 600 | 700 | 800 | 900 | 1000 | 1100 | 1200 | 1300 | 1400 | 1500 | 1600 | 1700 | 1800 | 1900 |

L

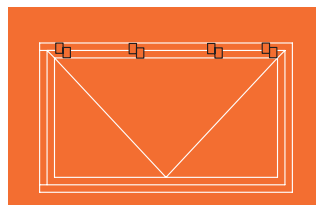
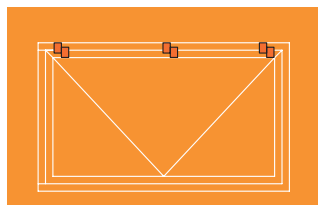
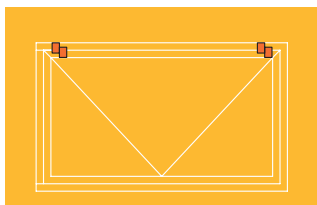

| ART. | * | PORTATA LOAD CAPACITY |
|--------------------|---|--------------------------|
| 3420.71 3420.72 | + | 100% = 120 Kg |
| 3421.72 | + | 100% = 110 Kg |

* OBBLIGATORIO
MANDATORY